



# MEDICURE

*Precision Tools For Professionals*

Pakistan's top Professional Dental Instruments Manufacturer

## DENTAL PRODUCTS CATALOG

- Diagnostic
- Periodontal
- Restorative
- Surgery
- Root Elevators
- Extraction forceps
- Microsurgery
- Dental Implant
- Endodontic
- Orthodontic
- Crown Instruments
- Dental Kits & Sets
- Educational Products

[www.medicure.pk](http://www.medicure.pk)



Medicure is a professional dental instrument manufacturing company focused on producing quality dental instruments and offering at very reasonable prices.

We have listed in our catalog the most regular range of dental instruments that are used by dentists' around the world in their general practice. These are the dental instruments that are commonly consumed and traded in dental industry around the world.

As the catalog contains with the most universal range of dental instruments, if you are unable to find the dental instruments you are looking for some specific purpose or usage. We are pleased to manufacture them for you with top quality standard comparatively at cost-effective prices

We are also specialized company in manufacturing custom made dental instruments and are capable to manufacture any sort of dental instruments in any design, patterns and standard , in this perspective, we can be given, drawing, image or reference of any international catalog. We also do manufacturing for the brands that market dental instruments

We are grateful for the loyal support given to us by our promoters, valuable customers and others who have been selling our top quality dental instruments in their markets with pride and honor.

## | DIAGNOSTIC

Diagnostic kits.....	D/2, D/3
Explorers, Single-end.....	D/4
Explorers.....	D/4
Probes, single-end.....	D/5
Handles for mouth mirrors.....	D/6
Mouth mirrors.....	D/7
Dressing pliers.....	D/8
Articulating papers forceps.....	D/8

## | ENDODONTICS

Pliers for holding point with self-locking.....	E/2
Pliers for removing broken broaches.....	E/2
Spreaders, Pluggers, Condensers.....	E/2

## | RESTORATIVE

Excavatorrs .....	R/2
Amalgam plugger/condensers.....	R/3
Plastic filling instruments.....	R/4
Composite instruments (TIN) .....	R/5
Amalgam burnishes.....	R/6
Carver.....	R/7
Titanium nitride (TIN) carvers.....	R/7
Cement spatulas.....	R/8
Heidemann spatulas.....	R/9
Placements instruments.....	R/10
Crown remover.....	R/10

## | PERIODONTAL

Sickle Scalers .....	P/2
Universal curettes.....	P/3
Gracey curettes.....	P/4, P/5
Gracy mini curettes.....	P/6
Sharpening accessories. ....	P/6
Sharpening stone.....	P/7
Sharpening stone.....	P/8

## | SURGERY

Periodontal Knives.....	S/2
Surgical chisels.....	S/2
Scalpel handles.....	S/3
scalpel blade remover.....	S/3
Surgical mallets.....	S/4
Surgical curettes.....	S/5
Periosteals.....	S/6, S/7
Sinus-lift instruments.....	S/7
Curettes for sinus- lift.....	S/7
Spatole modellballi- Retractor.....	S/9
Retractors.....	S/10, S/11
Osteotomes.....	S/12
Bone scrapers.....	S/12
Compactors.....	S/13
Bone Well.....	S/13
Bone mill.....	S/13
Surgical aspirators.....	S/14
Gum scissors. ....	S/15,17
Surgical Scissors.....	S/18
Surture Scissors.....	S/18
Needle Holders.....	S/19
Needle holders with tunsten carbide inserts.....	S/20,S/21
Hemostats.....	S/22
Sterilizing Forceps.....	S/22
Tissue Pliers.....	S/23, S/24
Peritome.....	S/25
Extracting forceps.....	S/26-S/31
Bone Rongeurs.....	S/33
Root elevators.....	S/34, S/35
Root tip pick / teaser.....	S/36
Root fragment removing pliers.....	S/36
Luxators.....	S/36

## | ORTHODONTICS

Pliers .....	O/2-O/5
Cutters / Distal and cutters with tungsten carbide inserts.....	O/9
D.B. Brackets holders.....	O/7
Orthodontic ligature pliers.....	O/7
Utility instruments.....	O/8

## | LABORATORY

Wax carves.....	L/2
P.K. Thomas waxing instruments.....	L/3
Ceramic sculpturing instruments.....	L/4
Wax knives.....	L/5
Plaster knives.....	L/5
Mixing Spatulas.....	L/6
Crown Scissors.....	L/7
Gold Foil Scissors.....	L/7
Scalpel handles.....	L/7
Alcohol lamp.....	L/7
Pliers / Laboratory Pliers.....	L/8
Mallets-calipers.....	L/9
Insulated soldering tweezers.....	L/10
Crucible tongs.....	L/10

# Handle Options



Scaler Single End 6mm Solid Handle



Scaler Single End 8mm Hollow Handle



Scaler Single End 10mm Hollow Handle



Scaler Double End 6mm Solid Handle



Scaler Double End 8mm Hollow Handle



Scaler Double End 10mm Hollow Handle



Dental Tweezer Plain Pattern



Dental Tweezer Learning Pattern

# Handle Options



Elevator Pattern #G01

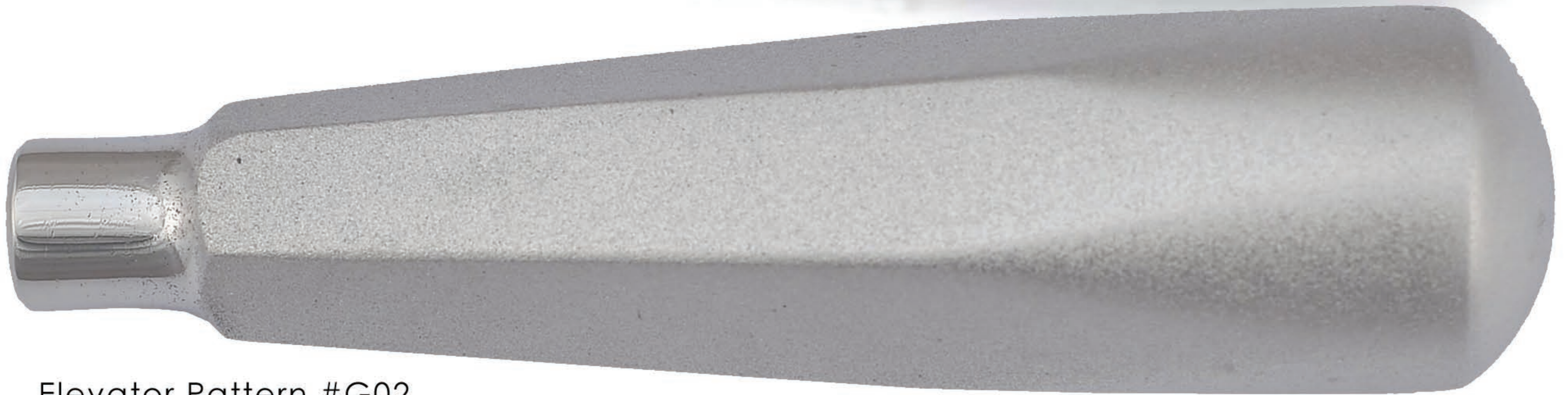

Elevator Pattern #G02



Extraction Forceps Pattern # P01



Extraction Forceps Pattern # S02



Extraction Forceps Pattern # SF03

# Diagnostic



**Diagnostic Kit**



**MIA001 MIA003**



**MIA001**  
Explorer single-end #2



**MIB002**  
Handle for mouth mirrors Ø 6 mm. round #2  
**MIB010 (kit MIA001)** Ø 22 mm. Plain #4P  
**MIB011 (kit MIA003)** Ø 24 mm. Plain #5P  
Mouth mirror



**MIB002**  
Dressing pliers #2 College

**MIA005 MIA007**



**MIA002**  
Explorer single-end #23



**MIB002**  
Handle for mouth mirrors Ø 6 mm. round #2  
**MIB010 (kit MIA005)** Ø 22 mm. - Plain #4P  
**MIB011 (kit MIA007)** Ø 24 mm. - Plain #5P  
Mouth mirror



**MIR002**  
Dressing pliers #2 College

**MIA009 MIA011**



**MIA002**  
Explorer single-end #9



**MIB002**  
Handle for mouth mirrors Ø 6 mm. round #2  
**MIB010 (kit MIA009)** Ø 22 mm. - Plain #4P  
**MIB011 (kit MIA011)** Ø 24 mm. - Plain #5P  
Mouth mirror



**MIR002**  
Dressing pliers #2 College

**MIA010**



**MIA003**  
Explorer single-end #9



**MIB002**  
Handle for mouth mirrors Ø 6 mm. round #2  
**MIB002**  
Mouth mirror plain Ø 22 mm. #4P



**MIR003**  
Dressing pliers #17 Flagg

**| Diagnostic kits**

**MIA017**



**MIA005**  
Explorer single-end #11



**MIB002**  
Handle for mouth mirrors Ø 6 mm. round #2  
**MIB010**  
Mouth mirror plain Ø 22 mm. #4P



**MIB002**  
Dressing pliers #2 College

**MIA033**



**MIA009**  
Explorer single-end #6A



**MIA002**  
Handle for mouth mirrors Ø 6 mm. round #2  
**MIA010**  
Mouth mirror plain Ø 22 mm. #4P



**MIA002**  
Dressing pliers #2 College

**MIA105**



**MIA002**  
Explorer single-end #23



**MIB002**  
Handle for mouth mirrors Ø 6 mm. round #2  
**MIB010**  
Mouth mirror plain Ø 22 mm. #4P



**MIR004**  
Dressing pliers #18 Meriam

**MIA109**



**MIA003**  
Explorer single-end #9



**MIB003**  
Handle for mouth mirrors Ø 6 mm. round #2  
**MIB010**  
Mouth mirror plain Ø 22 mm. #4P



**MIR004**  
Dressing pliers #18 Meriam

**MIA200**



**MIA020**  
Explorer double-end #23/17



**MIA002**  
Handle for mouth mirrors Ø 6 mm. round #2  
**MIB010**  
Mouth mirror plain Ø 22 mm. #4P



**MIB004**  
Dressing pliers #18 Meriam

**MIA337**



**MIA010**  
Explorer single-end #8



**MIB002**  
Handle for mouth mirrors Ø 6 mm. round #2  
**MIB010**  
Mouth mirror plain Ø 22 mm. #4P



**MIB004**  
Dressing pliers #18 Meriam



**| Explorers - single - end**



**MIA002**  
# 23



**MIA010**  
# 8



**MIA003**  
# 9



**MIA012**  
# 12



**MIA004**  
# 6



**MIA013**  
# 17



**MIA005**  
# 11



**MIA014**  
# 17A



**MIA009**  
# 6A

**| Explorers - single - end**



**MIA020**  
# 23/17



**MIA025**  
# DG16



**MIA027**  
# ODU 11/12

**| Probes - Single - End**



**MIA040**  
# W - Williams  
1-2-3-5-7-8-9-10



**MIA042**  
# 12S - WHO  
*Ball end*  
3-6-9-12



**MIA045**  
# 11.5 - WHO  
*Punta sferica - Ball end*  
3,5-5,5-8,5-11,5



**MIA043**  
# 11  
3-6-8-11



**MIA047**  
# 15  
1-2-3-4-5-6-7-8-9-10-11-12-13-14-15



**MIA044**  
# 12  
3-6-9-12



**MIA050**  
# C  
*Ball end*  
3-6-9-12



**| Probes - double - end**



**MIA060**  
# GF/W - Goldman-Fox/Williams  
1-2-3-5-7-8-9-10



**MIA061**  
# 1N - Nabers

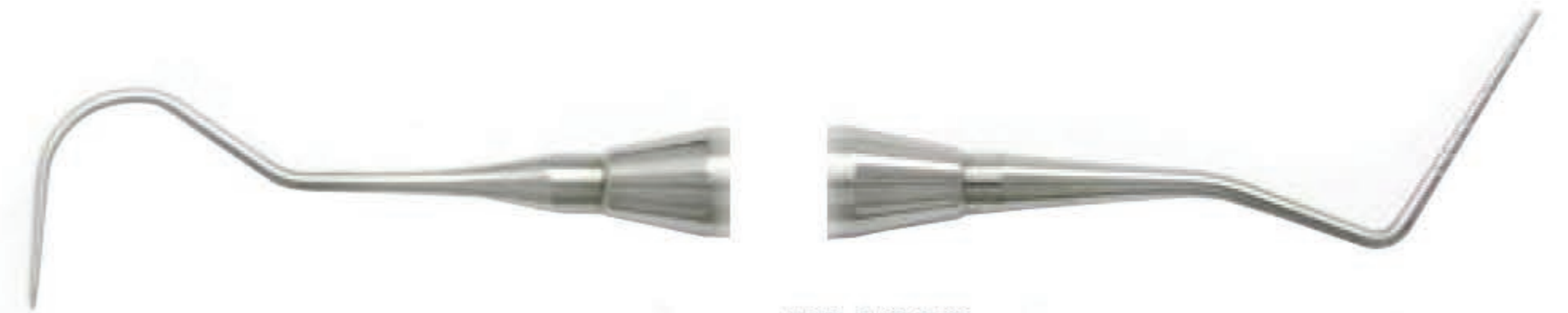

**MIA083**  
# 23/W - Williams  
1-2-3-5-7-8-9-10



**MIA063**  
# Q2N - Nabers  
3-6-9-12



**MIA087**  
# 23/15  
1-2-3-4-5-6-7-8-9-10-11-12-13-14-15

**| handles for mouth mirrors**



**MIB001**  
# 1  
Octagonal



**MIB002**  
# 2  
Ø 6 mm.



**MIB002**  
# 2A  
Ø 7 mm.

**| Mouth Mirrors**



**MIB010**  
# 4P  
Ø mm. 22 - Plane



**MIB011**  
# 5P  
Ø mm. 24 - Plane



**MIB014**  
# 4DS  
Ø mm. 22 - Plane  
Double side Rhodium surface.



**MIB015**  
# 5DS  
Ø mm. 24 - Plane  
Double side Rhodium surface.

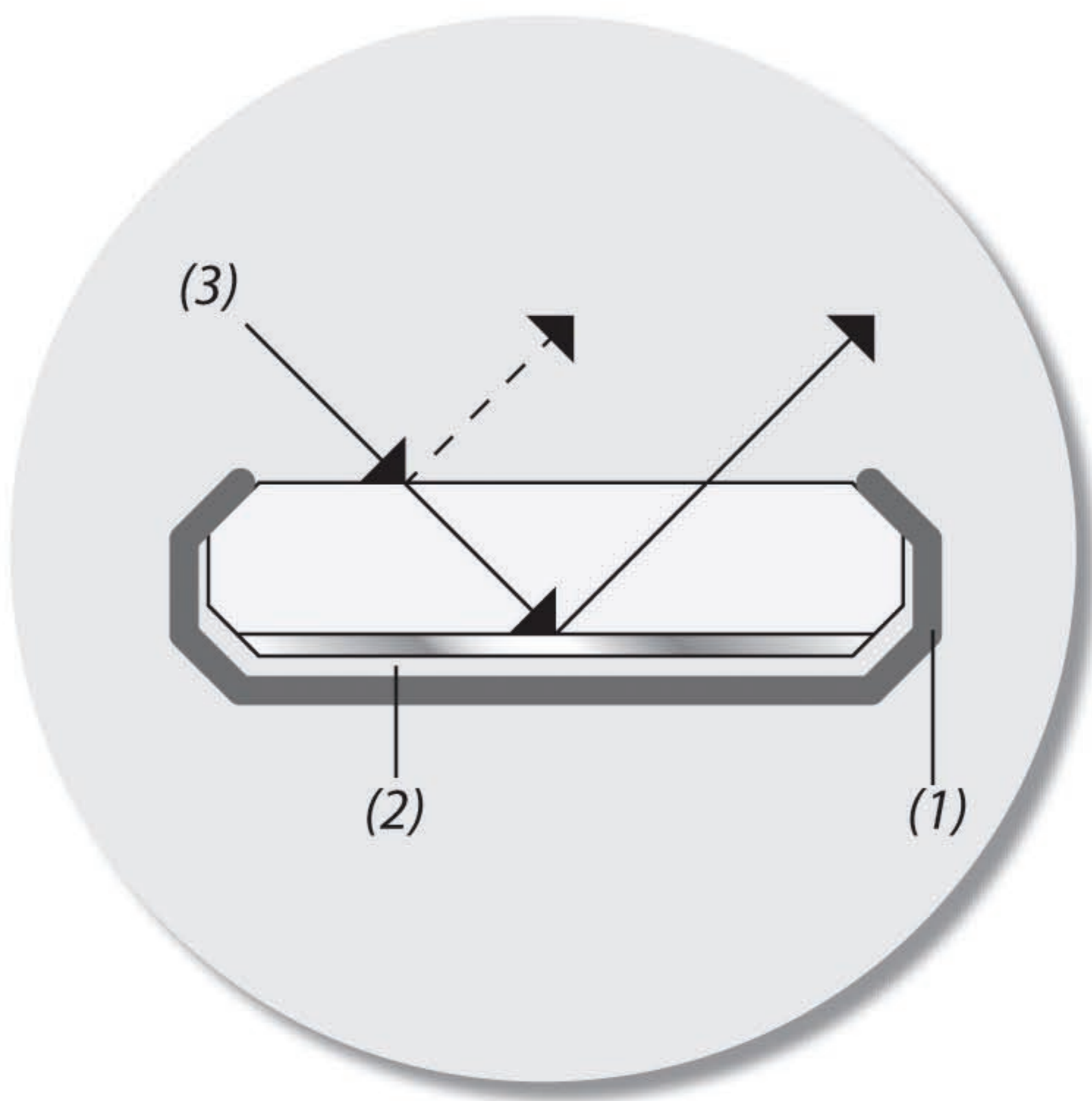

**ALUMINIUM - BACK SURFACE**

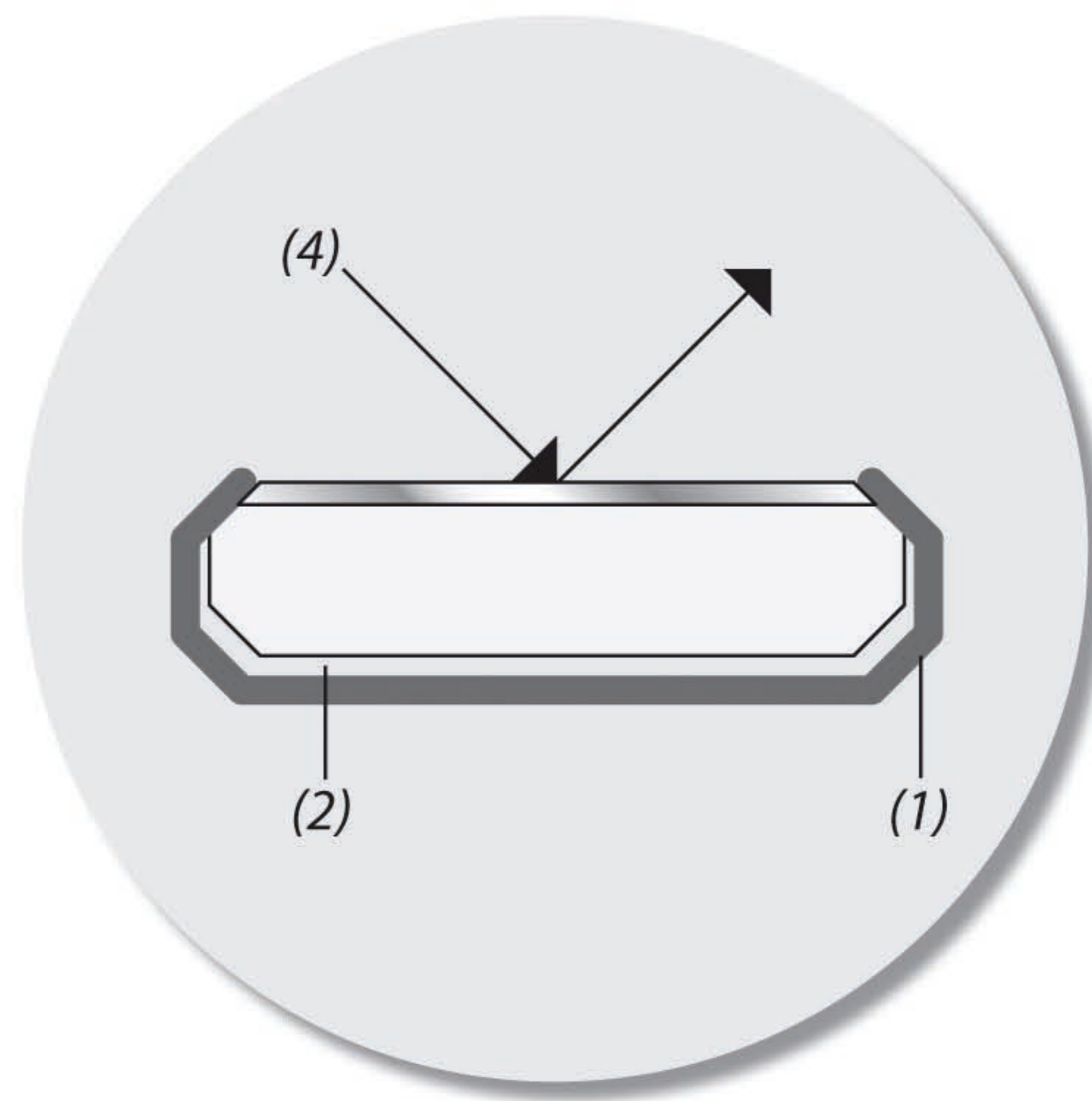

**RHODIUM - FRONT SURFACE**

1 - stainless steel frame

2 - sealed with waterproof seal

3 - reflective aluminum-coated back surface

4 - reflective rhodium-coated front surface

In mirrors with rhodium-coated front surface, the reflective surface is on the upper part of the mirror for precise and sharp reflected images. It is recommended to avoid contact between the mirror and abrasive surfaces. When cleaning, it also is recommended to avoid immersing the mirror in an ultrasonic tank.

**| Dressing Pliers**



**MIR002**  
# 1 - Perry



**MIR002**  
# 2 - College



**MIR003**  
# 17 - Flagg



**MIR002**  
# 18 - Meriam



**MIR010**  
# 18L  
*Autobloccante - Self-locking*

**articulating paper forceps**



**MIR050**  
# M1 - Miller  
*Straight*



**MIR075**  
# M2 - Miller  
*Curved*

# Endodontics

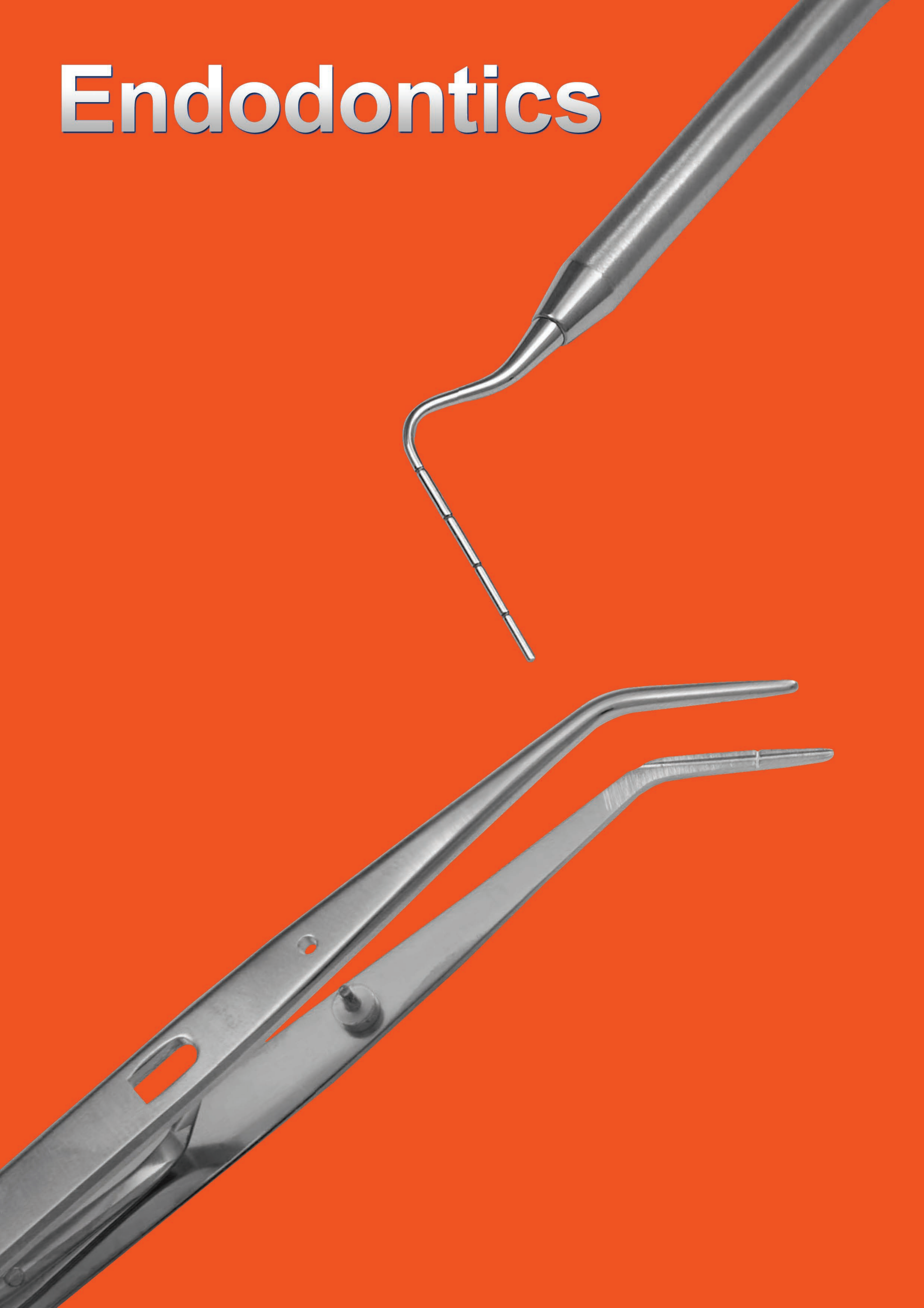

**| Pliers for holding points with self-locking**



**MIR020**  
# EP1

**| pliers for removing broken broaches**



**MIC072**  
# 1  
Straight

**MIC073**  
# 2  
Curved

**| spreaders, pluggers, condensers**

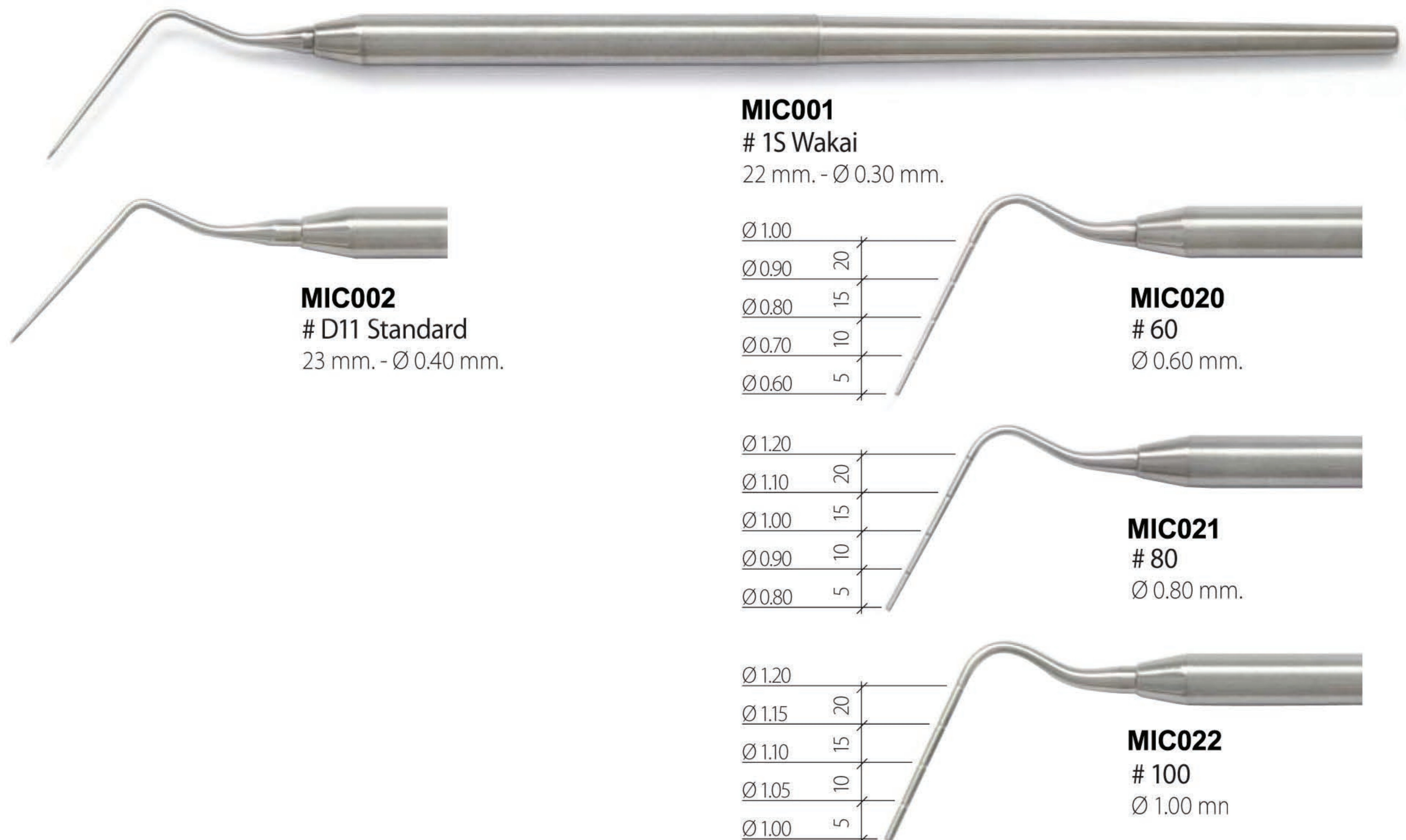

**MIC002**  
# D11 Standard  
23 mm. - Ø 0.40 mm.

**MIC001**  
# 1S Wakai  
22 mm. - Ø 0.30 mm.

Ø 1.00  
Ø 0.90 20  
Ø 0.80 15  
Ø 0.70 10  
Ø 0.60 5

**MIC020**  
# 60  
Ø 0.60 mm.

Ø 1.20  
Ø 1.10 20  
Ø 1.00 15  
Ø 0.90 10  
Ø 0.80 5

**MIC021**  
# 80  
Ø 0.80 mm.

Ø 1.20  
Ø 1.15 20  
Ø 1.10 15  
Ø 1.05 10  
Ø 1.00 5

**MIC022**  
# 100  
Ø 1.00 mm

# Restorative





**| Excavators**



**MIE001**  
# 0



**MIE002**  
# 1



**MIE031**  
# 17W



**MIE003**  
# 2



**MIE032**  
# 18



**MIE004**  
# 3



**MIE033**  
# 18W



**MIE005**  
# 4



**MIE040**  
# 38/39



**MIE020**  
# 6



**MIE050**  
# 31L



**MIE021**  
# 14

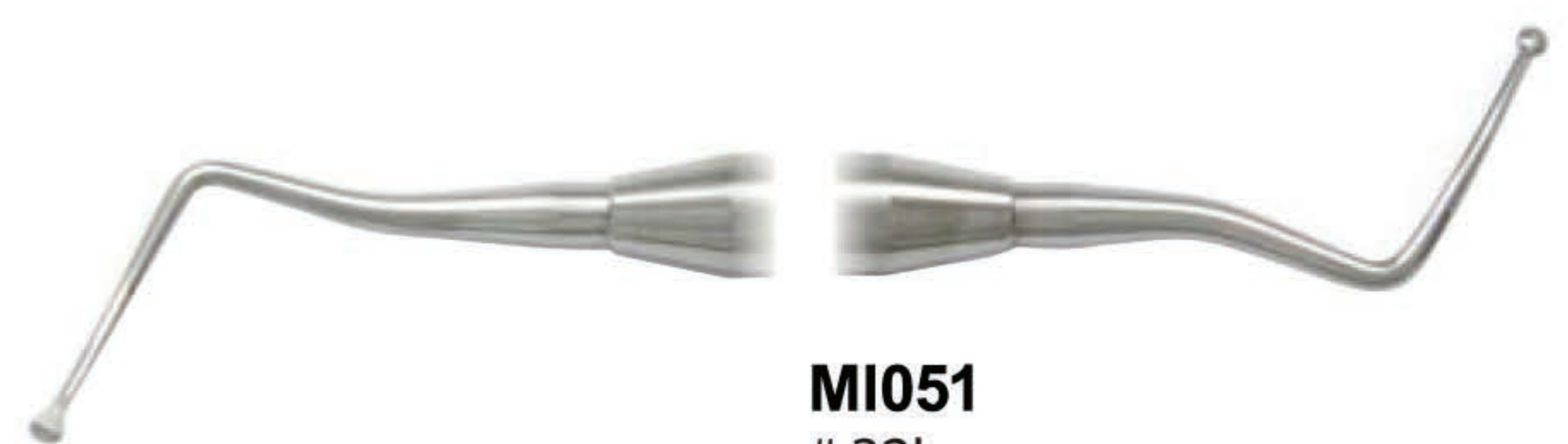

**MI051**  
# 32L



**MIE030**  
# 17



**MIE052**  
# 33L

**| Amalgam Pluggers / Condensers**

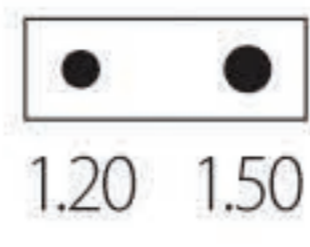

**MIF004**  
# 1CL

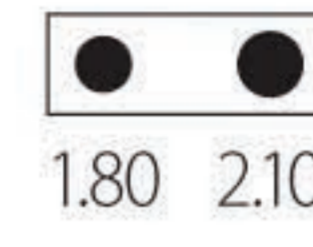

**MIG005**  
# 2CL

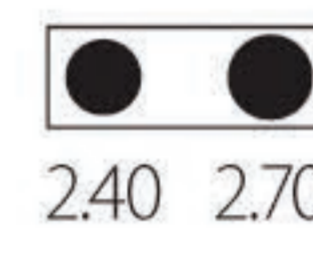

**MIG006**  
# 3CL

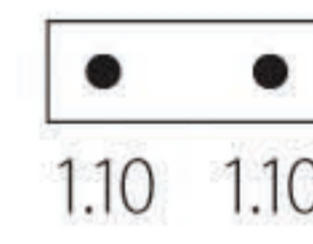

**MIG021**  
# 0 CL

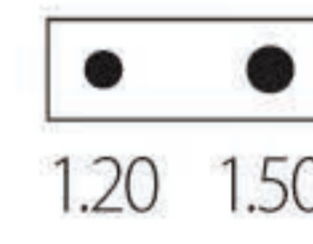

**MIG024**  
# 1 CLS  
*Serrated*

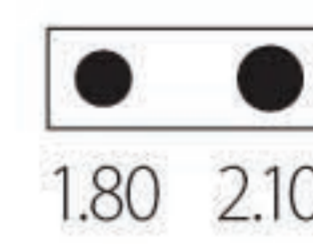

**MIG025**  
# 2 CLS  
*Serrated*



**MIB026**  
# 3 CLS  
*Serrated*



**| Plastic Filling Instruments**



**MIB001**  
# 10



**MIG037**  
# 11



**MIG042**  
# 3P



**MIG038**  
# 12



 **MIG050**  
# 1PS  
1.40 2.00  
mm.



**MIG040**  
# 1P



 **MIG051**  
# 2PS  
1.90 2.50  
mm.



**MIG041**  
# 2P



 **MIG052**  
# 3PS  
3.00 3.00  
mm.



**TIN**

*TIN (titanium nitride), which has always been very fascinating for its shimmering gold coloring, was the first coating to be successfully used in dentistry due to its high biocompatibility. The TIN coating significantly increases the micro-hardness of the instrument. These features, together with a low coefficient of friction, render it the ideal coating for all the instruments that come in contact with any composites and cements.*

**| Titanium Nitride ( TIN ) Composite Instruments**



Ø6 mm. handle

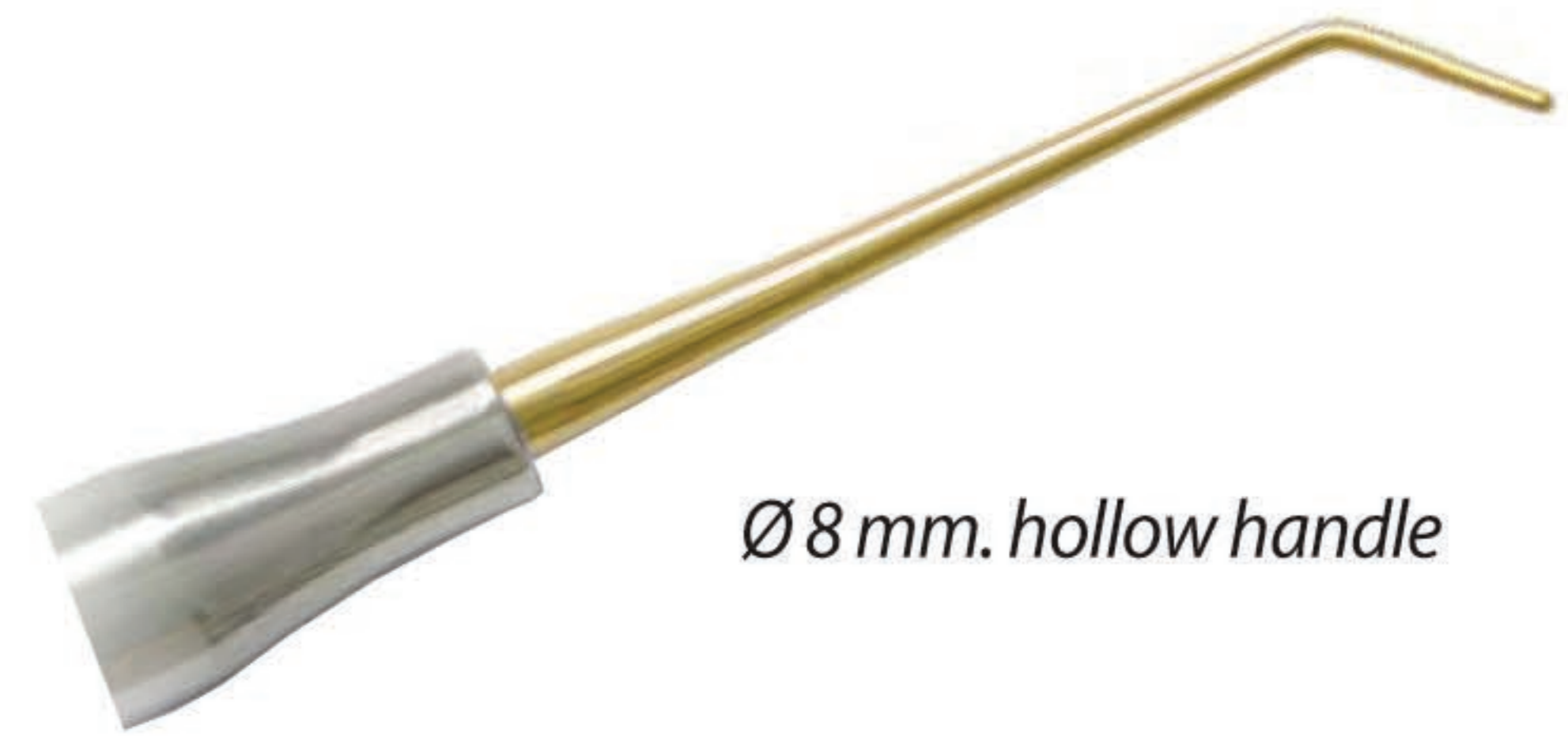

Ø8 mm. hollow handle



**MIG090**  
# 4



**MIG190**  
# 4

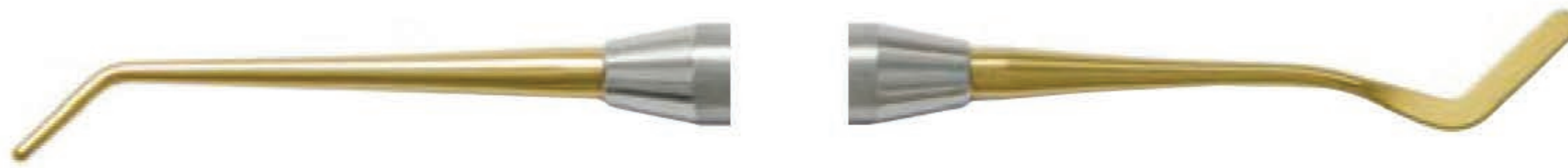

**MIG091**  
# 5



**MIG191**  
# 5



**MIG092**  
# 6



**MIG192**  
# 6



**MIG093**  
# 9



**MIG193**  
# 9



**MIG094**  
# F4 - Felt



**MIG194**  
# F4 - Felt



**MIG103**  
# G4 - Goldstein

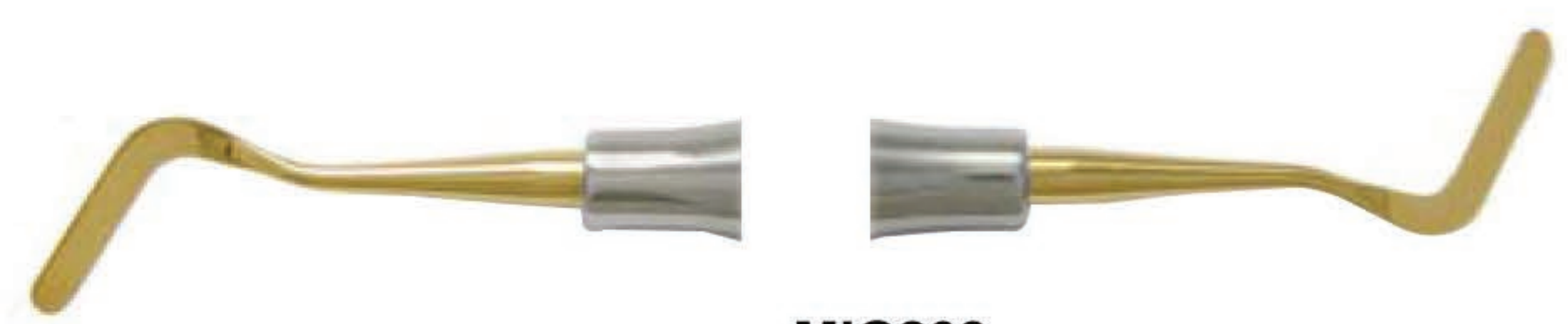

**MIG203**  
# G4 - Goldstein



**MIG104**  
# 3R



**MIG204**  
# 3R



**MIG105**  
# 10



**MIG205**  
# 10

**| Amalgam Burnishers**

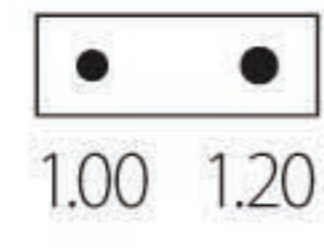

**MIG060**  
# 1PL

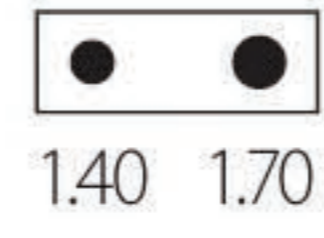

**MIG061**  
# 2PL

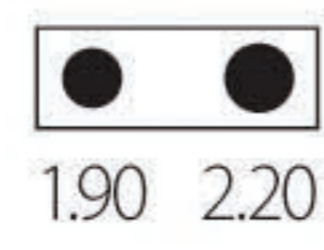

**MIG062**  
# 3PL



**MIG066**  
# 1WT - Westcott



**MIG067**  
# 2WT - Westcott

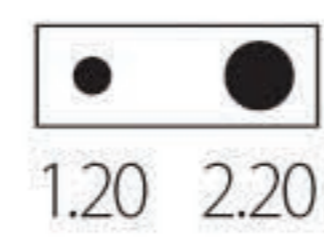

**MIG062**  
# 27/29B - Ball

**| Carvers**



**MIA002**  
# 1/2HL - Hollenback



**MIH003**  
# 3SHL - Hollenback



**MFH011**  
# 2 IPOA - Interproximal Off-Angle



**MIH004**  
# 3HL - Hollenback



**MFH015**  
# 8



**MIH010**  
# 1 IP - Interproximal

**| cleoid-discoid**



**MIH040**  
# CD 1/2



**MIH041**  
# CD 89/92

**| titanium nitride (tin) carvers**



**MIH090**  
# 1 IP - Interproximal  
*Hollow handle*  
Ø 8 mm.



**MIH091**  
# 2 IPOA - Interproximal Off-Angle  
*Hollow handle Ø 8 mm.*

**| Cement Spatulas**



**MIJ001**  
# 00



**MIJ002**  
# 0



**MIJ003**  
# 1



**MIJ004**  
# 2



**MIJ005**  
# 3



**MIJ010**  
# 2S

| **Heidemann spatulas**



**MIK001**   **MIK011**  
# HD1   # HD1R  
*Flexible*   *Rigid*



**MIK002**   **MIK012**  
# HD2   # HD2R  
*Flexible*   *Rigid*



**MIK003**   **MIK013**  
# HD3   # HD3R  
*Flexible*   *Rigid*





**| Placement Instruments**



**MIA060**  
# CHP 1



**MIA060**  
# CHP 2



**MIF003**  
# CHP 3

**| crown remover**



**MIF100**  
# CR  
3 tips included



**MIF101**  
# 1



Retro  
Back

Fronte  
Front

**MIF102**  
# 2



**MIF103**  
# 3

# Periodontal

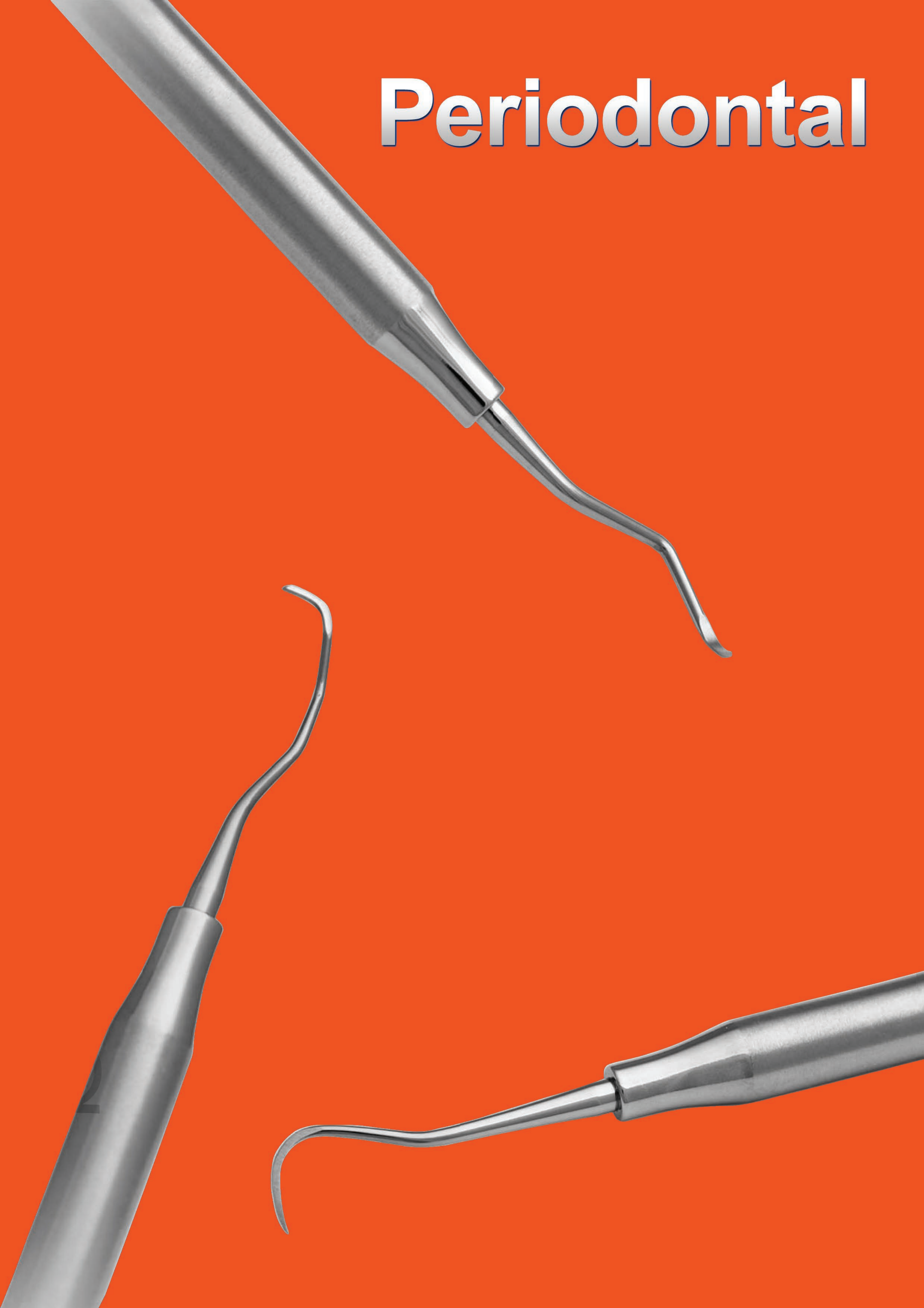

**Sickle Scalers**  
Hollow handle 08 mm.



3...1	1...3
3...1	1...3

**MIM015**  
# U15/33 - Towner-Jaquette



3...1	1...3
3...1	1...3

**MIM016**  
# U15/30 - Towner-Jaquette



8...6	6...8
8...6	6...8

**MIM028**  
# 11/12 MC - McCall  
*Mesial*



5...1	1...5
5...1	1...5

**MIM017**  
# H5/33



8...6	6...8
8...6	6...8

**MIM030**  
# 13/14 MC - McCall  
*Distal*



5...1	1...5
5...1	1...5

**MIM018**  
# H6/H7



8...1	1...8
8...1	1...8

**MIM031**  
# 13S/14S MC - McCall

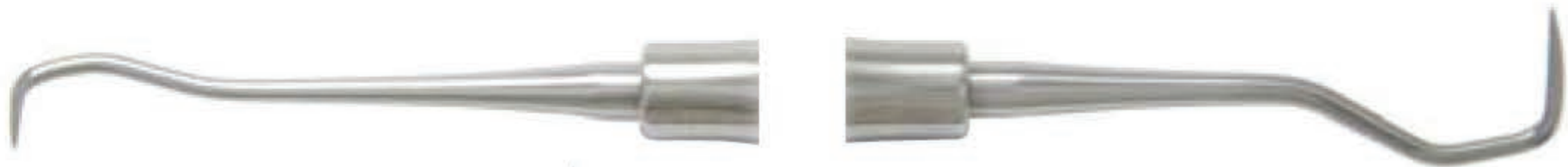

5...1	1...5
5...1	1...5

**MIM019**  
# 30/33 - Jaquette



8...6	6...8
8...6	6...8

**MIM032**  
# 17S/18S MC - McCall  
*Distal*



8...1	1...8
8...1	1...8

**MIM023**  
# T2/T3 - Taylor



8...1	1...8
8...1	1...8

**MIM035**  
# M23



8...4	4...8
8...4	4...8

**MIM024**  
# 204



8...4	4...8
8...4	4...8

**MIM036**  
# 204SD



8...6	6...8
8...6	6...8

**MIM025**  
# 204S

**| Universal Curettes**

Hollow handle 08 mm.



3...1	1...3	<b>MIM070</b> # 2R/2L C - Columbia
3...1	1...3	



8...4	4...8	<b>MIM071</b> # 4R/4L C - Columbia
8...4	4...8	



8...4	4...8	<b>MIM086</b> # L 3/4 - Langer
-	-	



8...4	4...8	<b>MIM072</b> # 13/14 C - Columbia
8...4	4...8	



3...1	1...3	<b>MIM087</b> # L 5/6 - Langer
3...1	1...3	



8...6	6...8	<b>MIM073</b> # YG7/8 - Younger Good
8...6	6...8	



8...1	1...8	<b>MIM088</b> # M 23A
8...1	1...8	



-	-	<b>MIM085</b> # L 1/2 - Langer
8...4	4...8	



8...1	1...8	<b>MIM088</b> # M 23B
8...1	1...8	

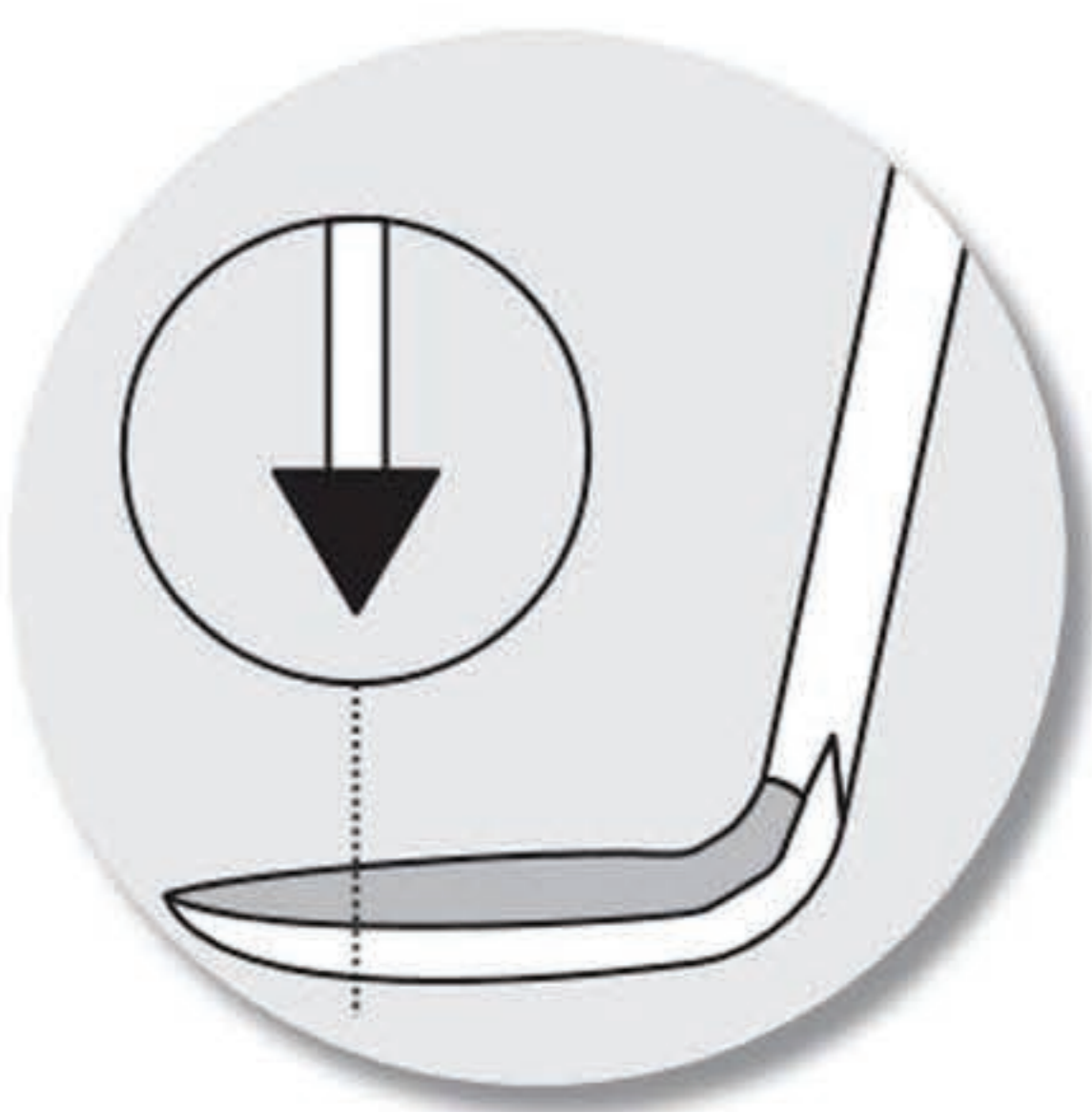

**Straight and curved sickle scalers** feature:

- 2 cutting edges
- curved facial component
- tipped ends

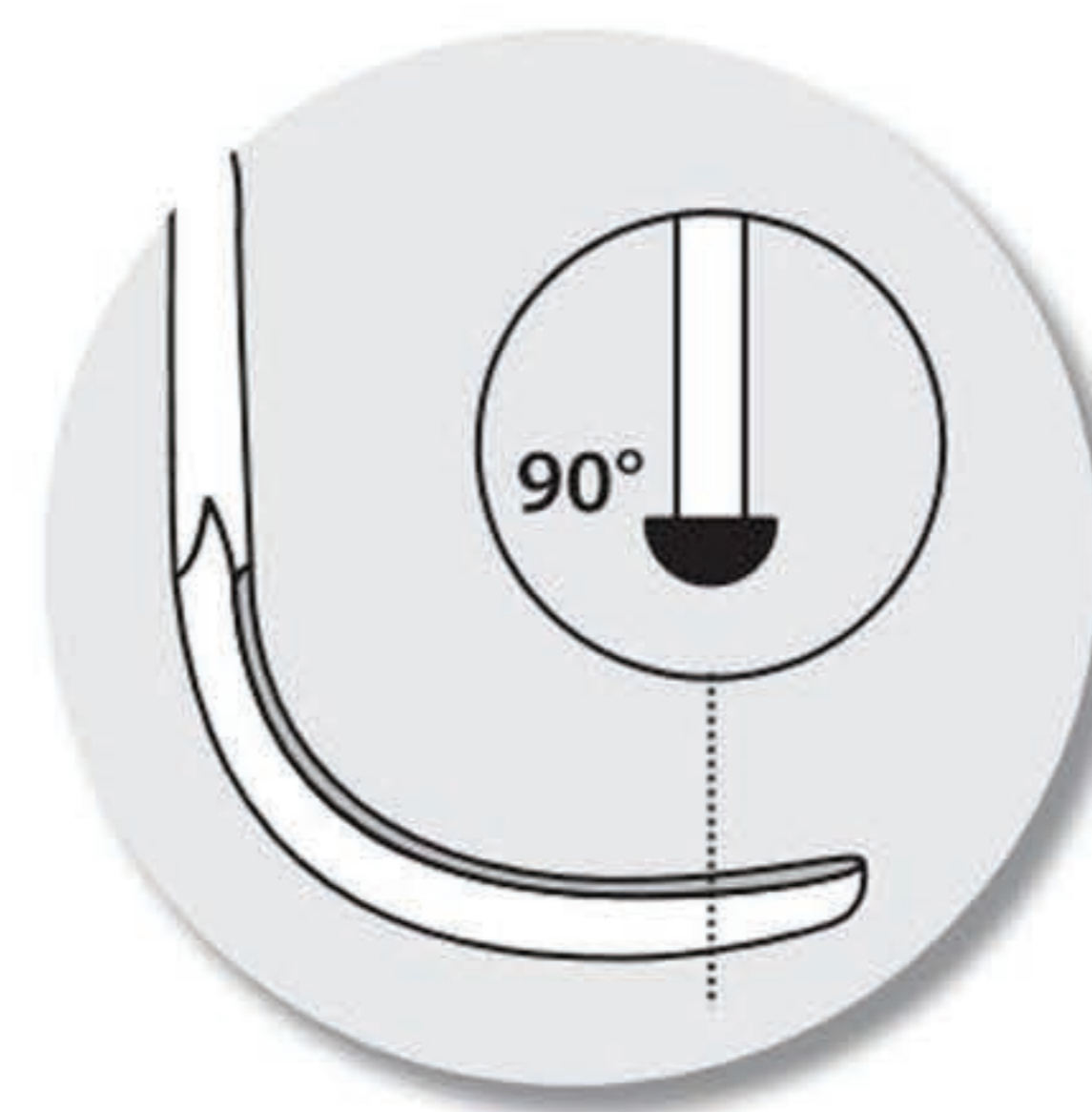

**Universal curettes** are characterized by an angle of 90° between the terminal stem and the cutting component.

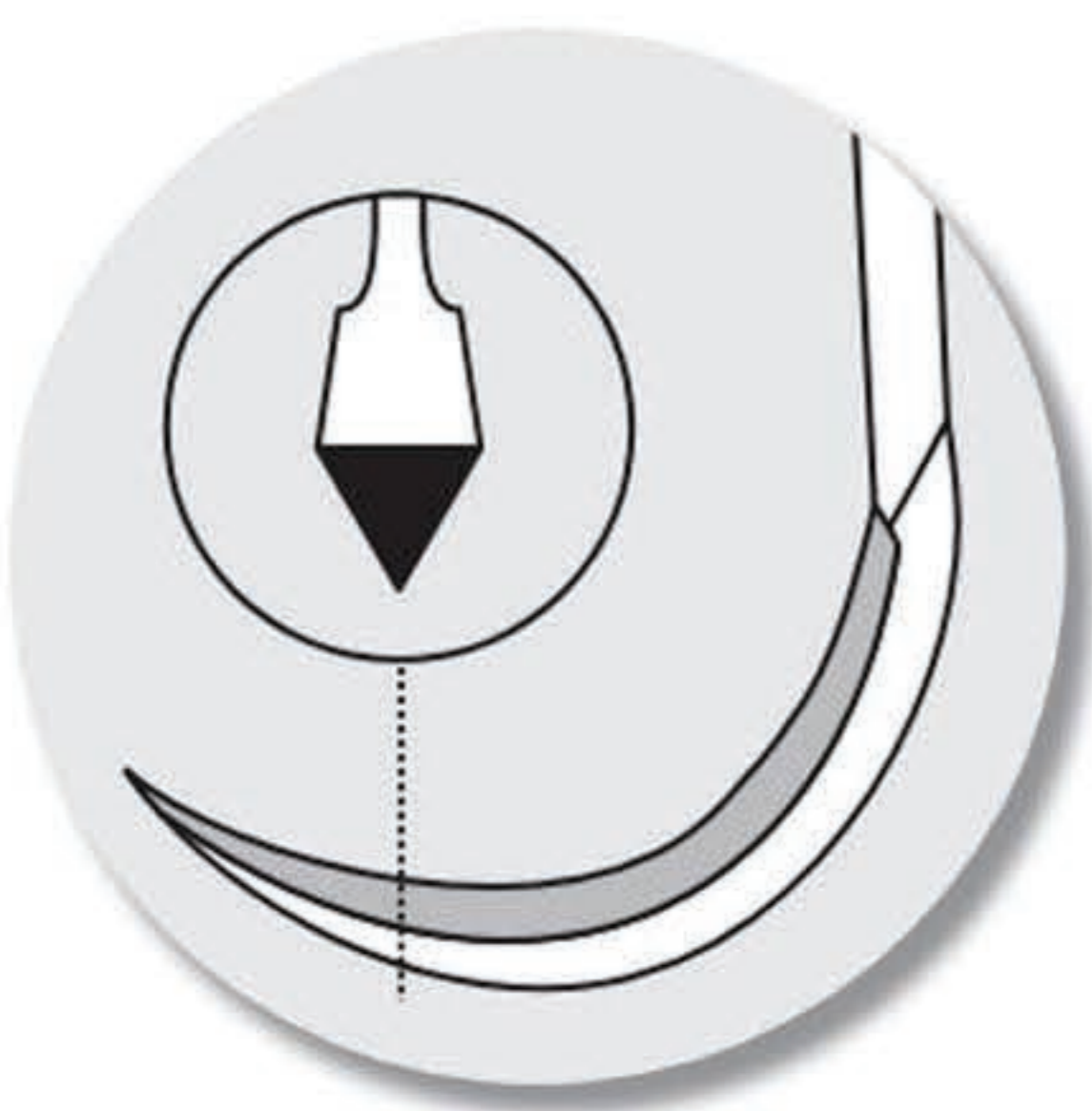

**Gracey curettes** are characterized by an angle of 70° between the terminal stem and the cutting component.

**| Gracey curettes**

- Hollow handle Ø8 mm.



3...1	1...3
3...1	1...3

**MIM100**  
# 1/2 GR - Gracey  
*Buccal surfaces*



5...1	1...5
5...1	1...5

**MIM101**  
# 3/4 GR - Gracey  
*palatal surfaces*



5...1	1...5
5...1	1...5

**MIM102**  
# 5/6 GR - Gracey



8...4	4...8
8...4	4...8

**MIM103**  
# 7/8 GR - Gracey  
*palatal surfaces*



8...4	4...8
8...4	4...8

**MIM104**  
# 9/10 GR - Gracey  
*palatal surfaces -  
More angled*



8...4	4...8
8...4	4...8

**MIM105**  
# 11/12 GR - Gracey  
*Mesial*



8...4	4...8
8...4	4...8

**MIM106**  
# 13/14 GR - Gracey  
*Distal*

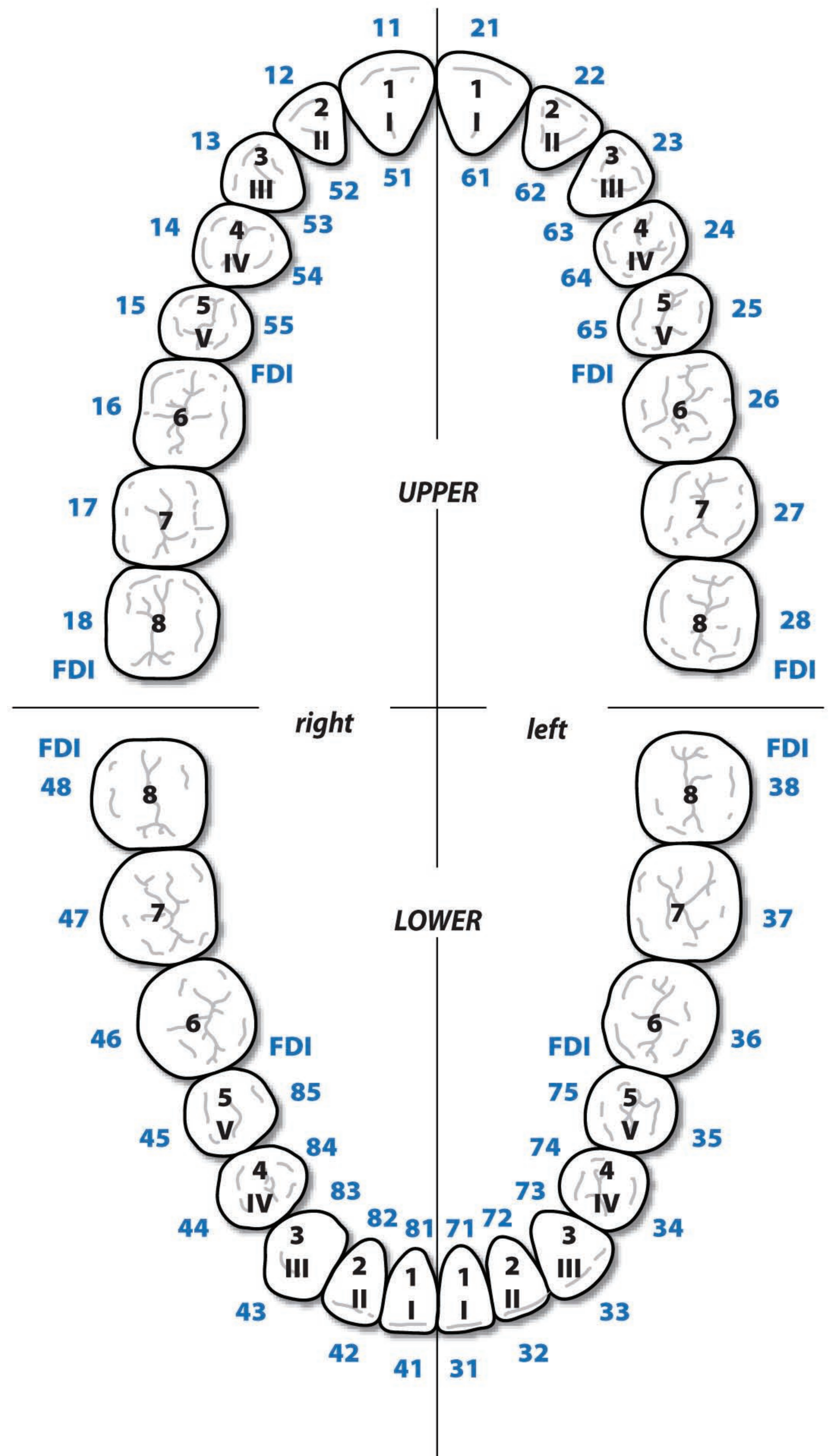

**| Gracey Curettes**

- Hollow handle Ø 10 mm.



3...1	1...3
3...1	1...3

**MIM200**  
# 1/2 GR - Gracey  
*Buccal surfaces*



5...1	1...5
5...1	1...5

**MIM201**  
# 3/4 GR - Gracey  
*Lingual/palatal surfaces*



8...4	4...8
8...4	4...8

**MIM205**  
# 11/12 GR - Gracey  
*Mesial*

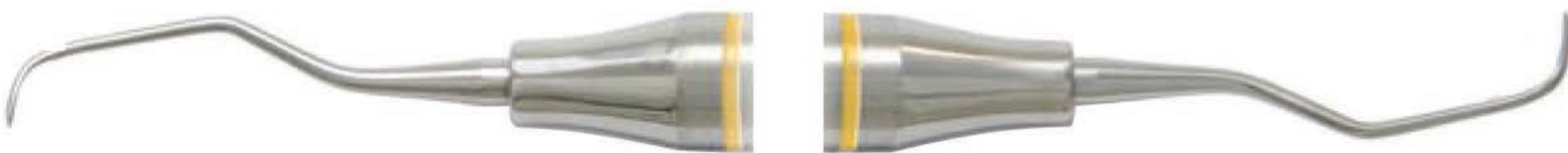

5...1	1...5
5...1	1...5

**MIM202**  
# 5/6 GR - Gracey

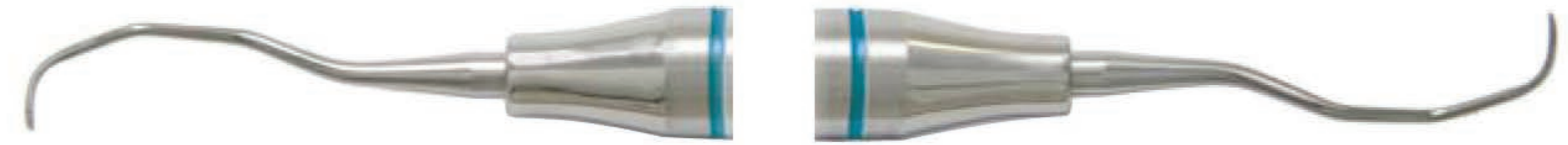

8...4	4...8
8...4	4...8

**MIM206**  
# 13/14 GR - Gracey  
*Distal*

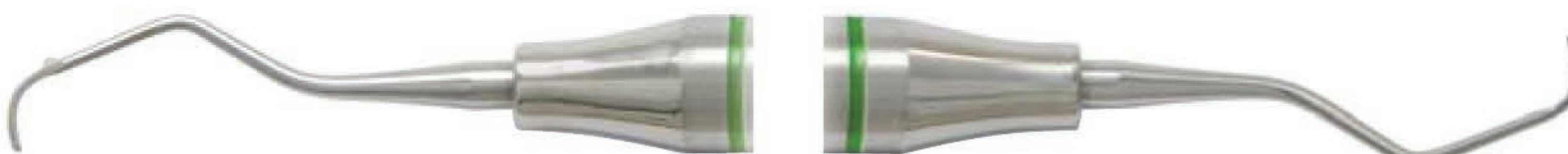

8...4	4...8
8...4	4...8

**MIM203**  
# 7/8 GR - Gracey  
*palatal surfaces*

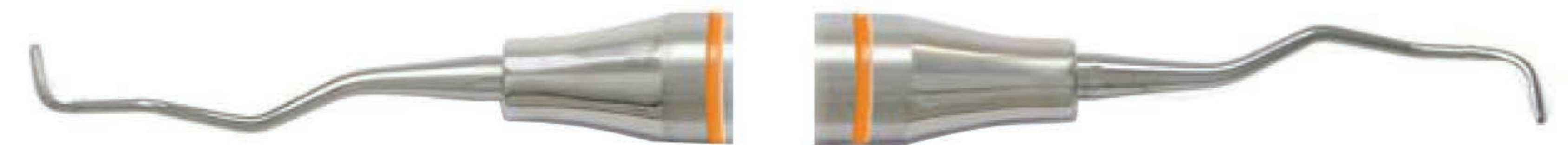

8...4	4...8
8...4	4...8

**MIM207**  
# 15/16 GR - Gracey  
*Mesial*



8...4	4...8
8...4	4...8

**MIM204**  
# 9/10 GR - Gracey  
*palatal surfaces -  
More angled*

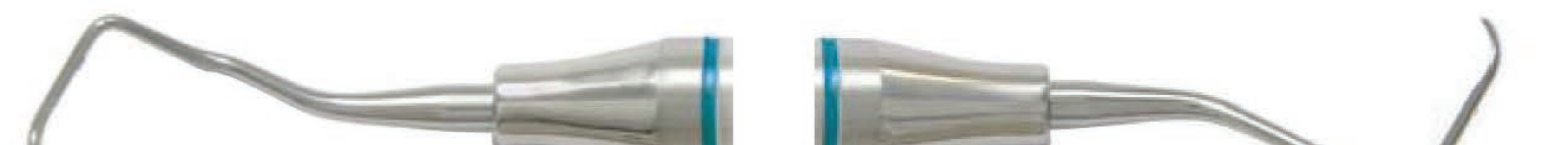

8...4	4...8
8...4	4...8

**MIM208**  
# 17/18 GR - Gracey  
*Distal*

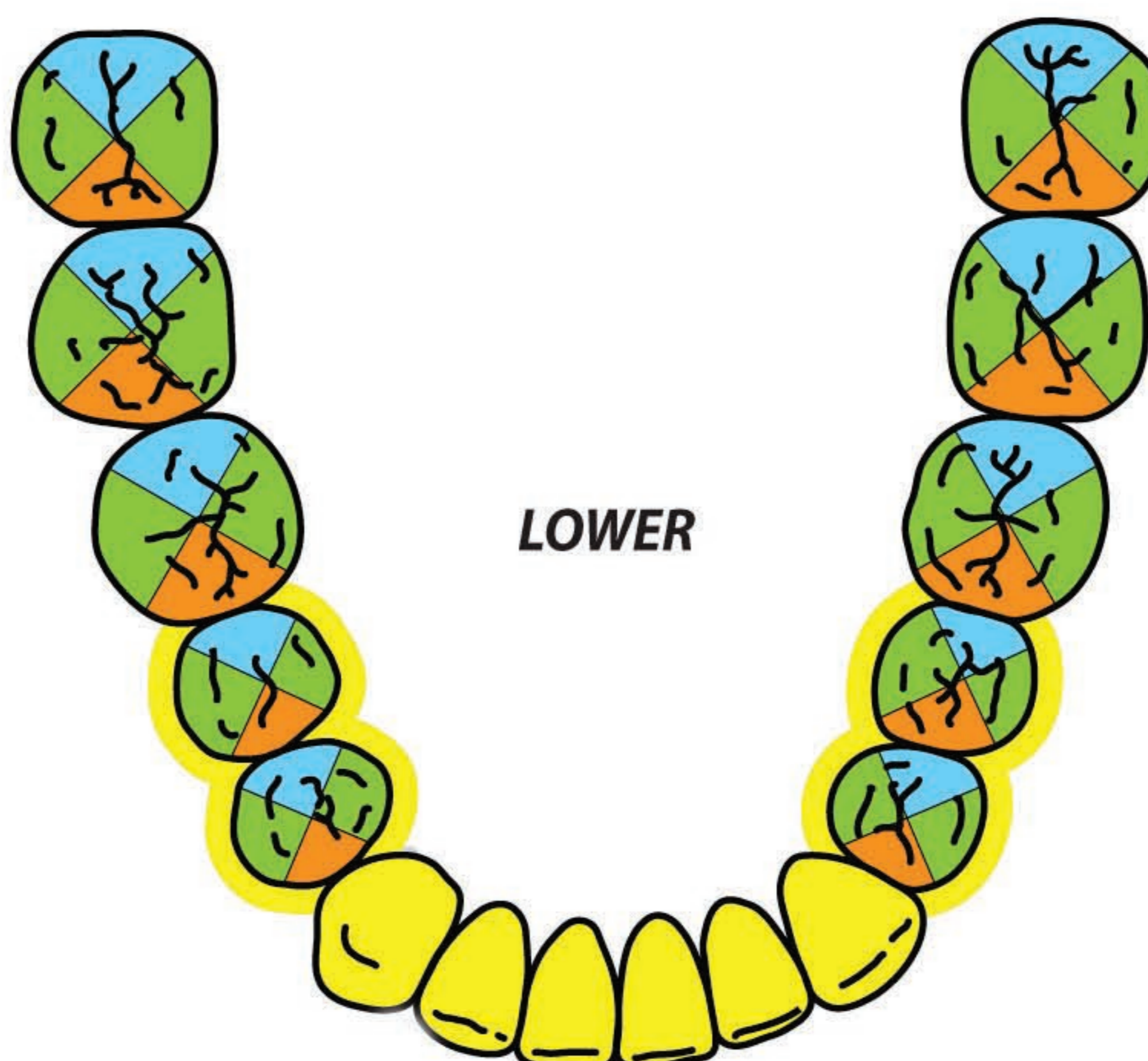
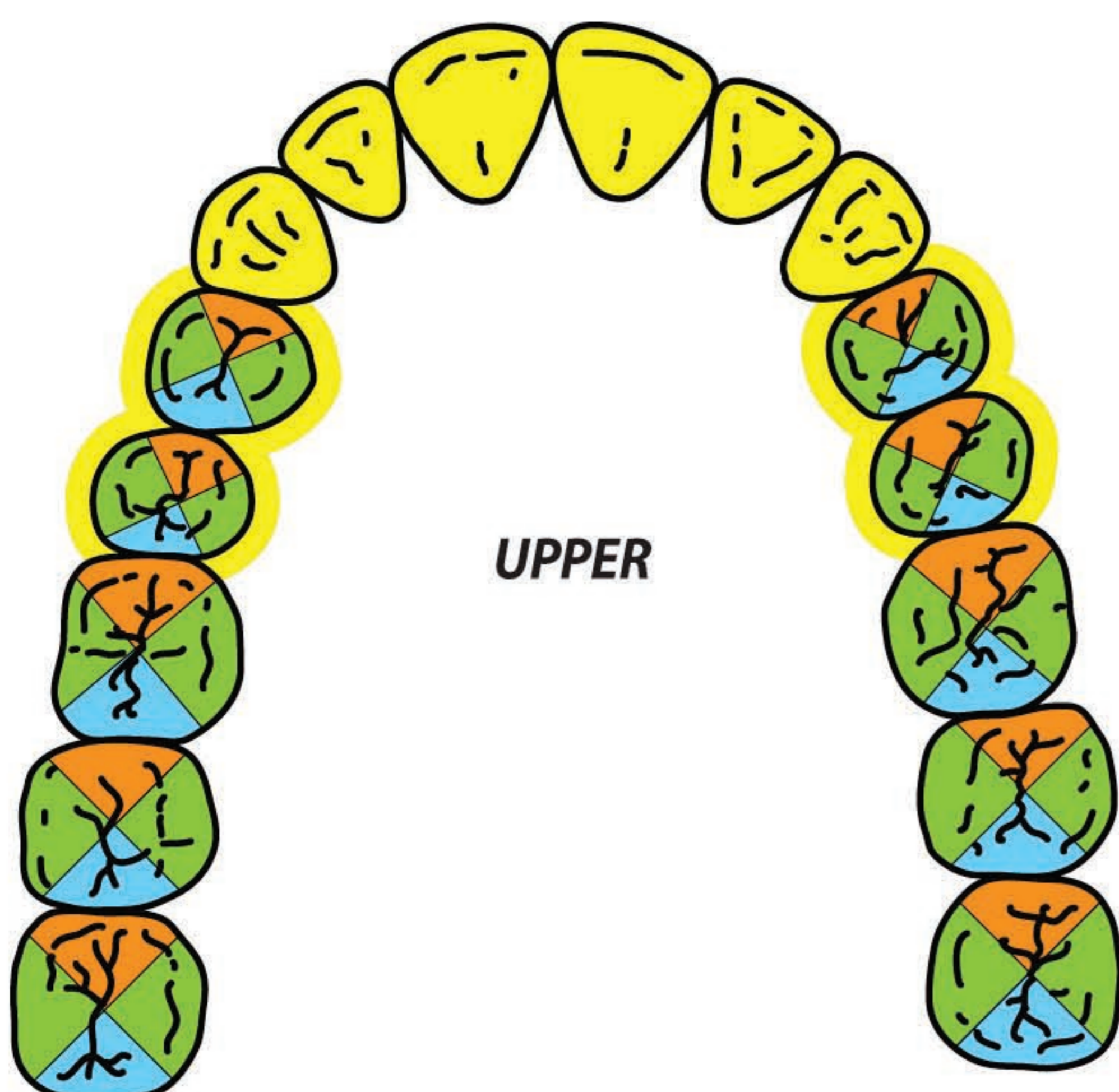

- # 1/2 - # 3/4 - # 5/6
- # 7/8 - # 9/10
- # 11/12 - # 15/16
- # 13/14 - # 17/18

**| Gracey mini-curettes**

Hollow handle Ø 8 mm.



3...1	1...3
3...1	1...3

**MIM140**  
# 1/2 GRL 3M - Gracey



5...1	1...5
5...1	1...5

**MIM141**  
# 3/4 GRL 3M - Gracey



8...4	4...8
8...4	4...8

**MIM145**  
# 11/12 GRL 3M - Gracey  
*Mesial*



5...1	1...5
5...1	1...5

**MIM142**  
# 5/6 GRL 3M - Gracey



8...4	4...8
8...4	4...8

**MIM146**  
# 13/14 GRL 3M - Gracey  
*Distal*



8...4	4...8
8...4	4...8

**MIM143**  
# 7/8 GRL 3M - Gracey  
*palatali*

**Titanium Blue Gracey-Curettes**

- Hollow handle Ø 10 mm.



3...1	1...3
3...1	1...3

**MIM800**  
# 1/2 GR - Gracey



5...1	1...5
5...1	1...5

**MIM801**  
# 3/4 GR - Gracey  
*Lingual/palatal surfaces*

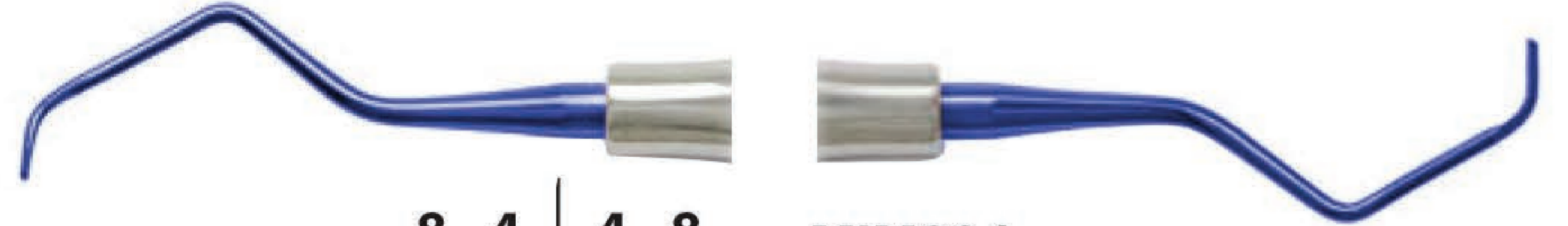

8...4	4...8
8...4	4...8

**MIM804**  
# 9/10 GR - Gracey  
*Buccal and lingual/palatal surfaces -  
More angled*



5...1	1...5
5...1	1...5

**MIM802**  
# 5/6 GR - Gracey



8...4	4...8
8...4	4...8

**MIM805**  
# 11/12 GR - Gracey  
*Mesial*



8...4	4...8
8...4	4...8

**MIM803**  
# 7/8 GR - Gracey



8...4	4...8
8...4	4...8

**MIM806**  
# 13/14 GR - Gracey  
*Distal*

**Titanium Blue Scalers**

Hollow handle Ø 10 mm.



5...1	1...5
5...1	1...5

**MIM817**  
# H 5/33



5...1	1...5
5...1	1...5

**MIM818**  
# H 6/7



8...6	6...8
8...6	6...8

**MIM825**  
# 204 S

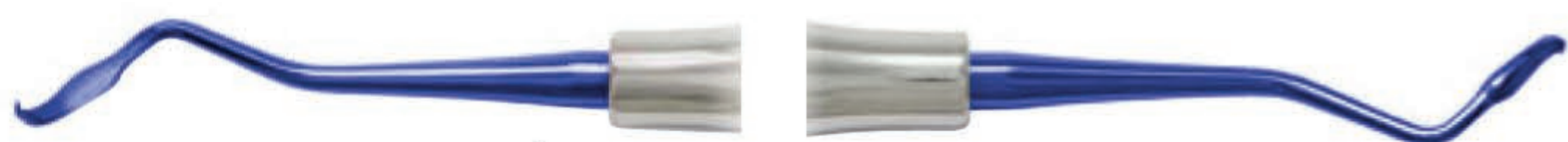

8...1	1...8
8...1	1...8

**MIM823**  
# T2/T3 - Taylor



8...4	4...8
8...4	4...8

**MIM836**  
# 204 SD



# Surgery



| **Periodontal Knives**



**MIM005**  
# 15K/16K - Kirkland



**MIM006**  
# 1/2 O - Orban



**MIM008**  
# 8 GF - Goldman-Fox



**MIM010**  
# 11 GF - Goldman-Fox

| **surgical chisels**



**MIP005**  
# 36/37 RH - Rhodes



**MIP001**  
# 1 OB - Ochsenbein



**MIP002**  
# 2 OB - Ochsenbein

**| Scalpel Handles**

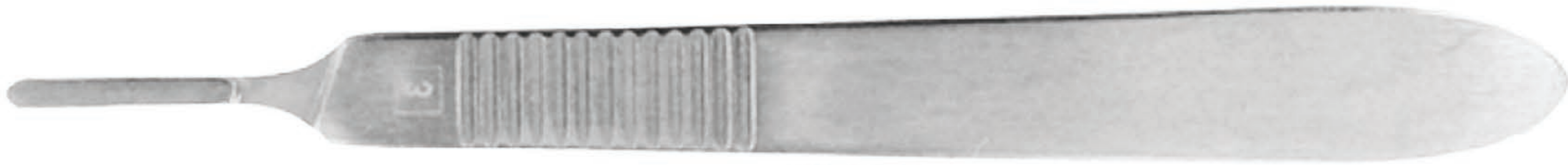

**MIU001  
#3**



**MIU002  
#3**



**MIU003  
#4**



**MIU004  
#3L**

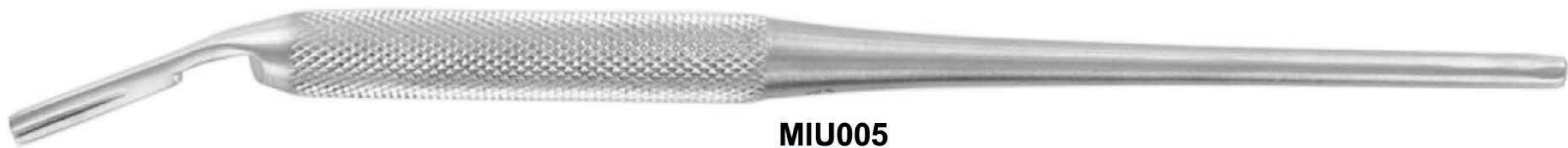

**MIU005**



**MIU006  
14.5cm**



**MIU007  
16.2cm Scalpel adjustable  
180 degree**



**| scalpel blade remover**



**MIU050**

| **Surgical Mallets**



**MIP020**  
# MM20 - Mead  
cm. 18,5



**MIP021**  
# MM19 - Mead  
cm. 18,5

**| Surgical Currettes**



**MIQ001**  
# 1 HY - Hemingway

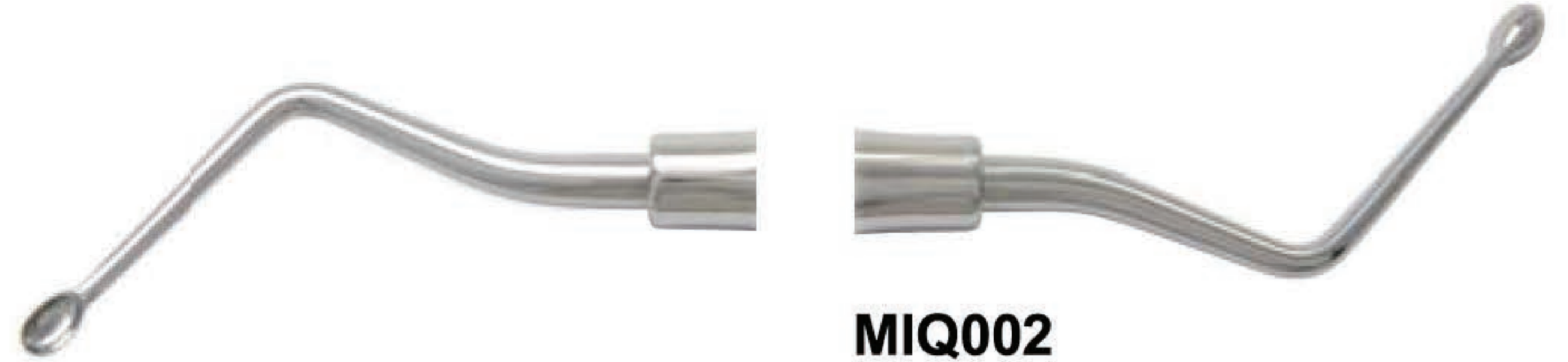

**MIQ002**  
# 2 HY - Hemingway

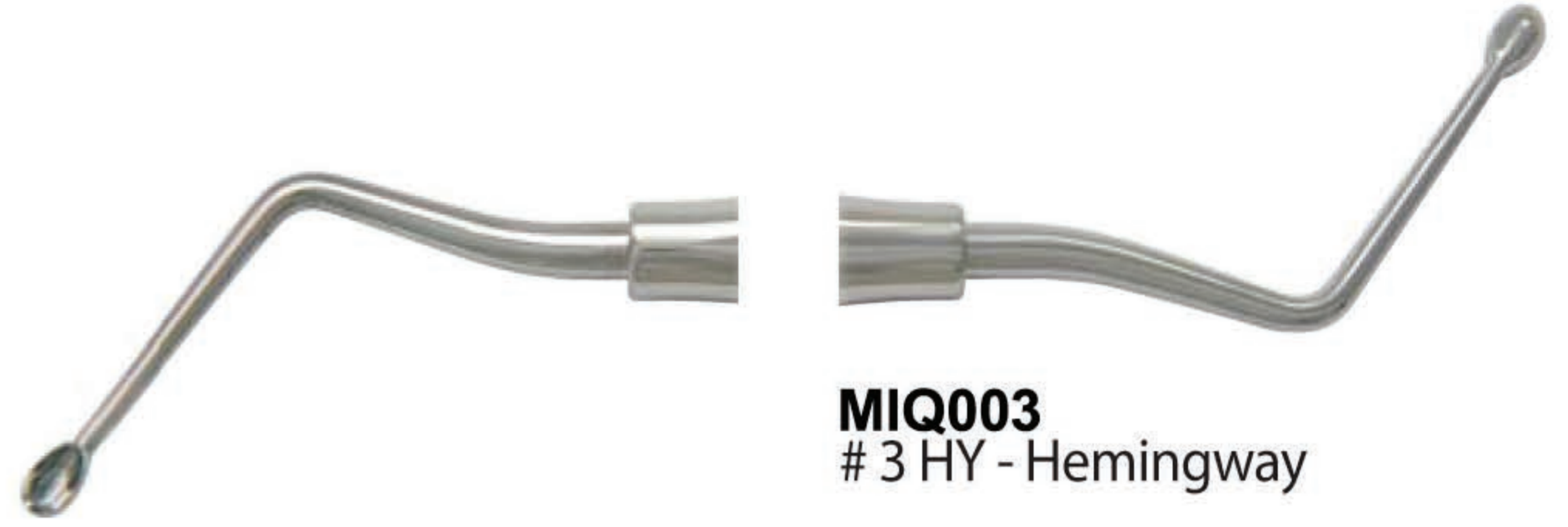

**MIQ003**  
# 3 HY - Hemingway

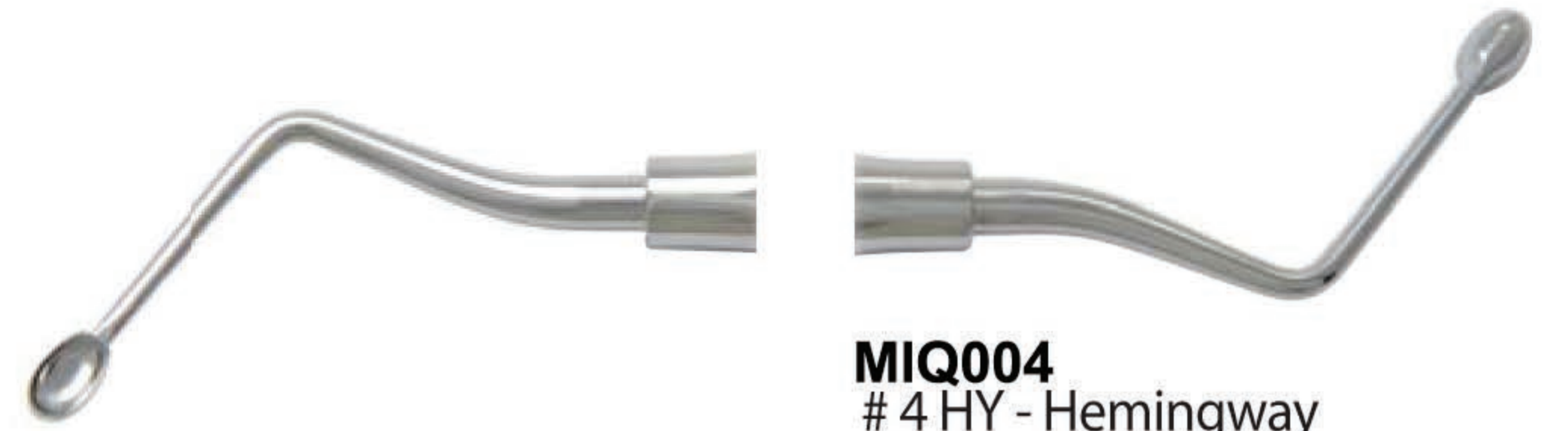

**MIQ004**  
# 4 HY - Hemingway

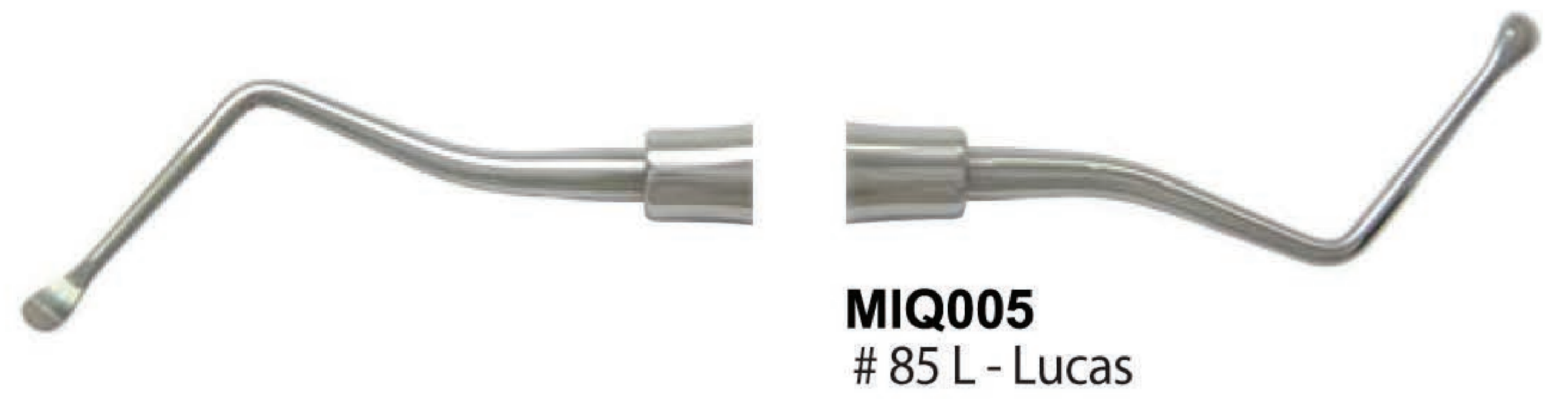

**MIQ005**  
# 85 L - Lucas



**MIQ006**  
# 86 L - Lucas

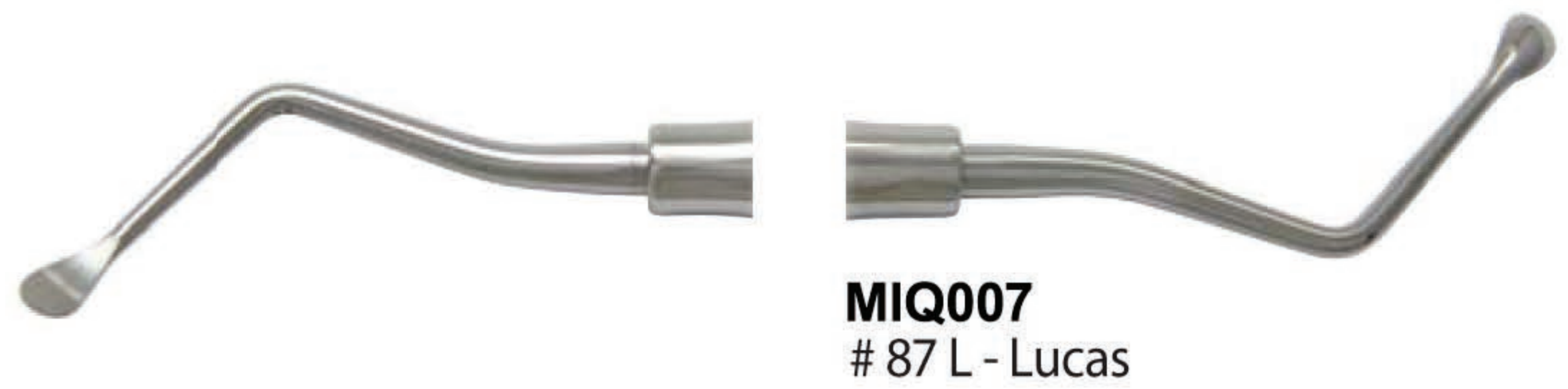

**MIQ007**  
# 87 L - Lucas

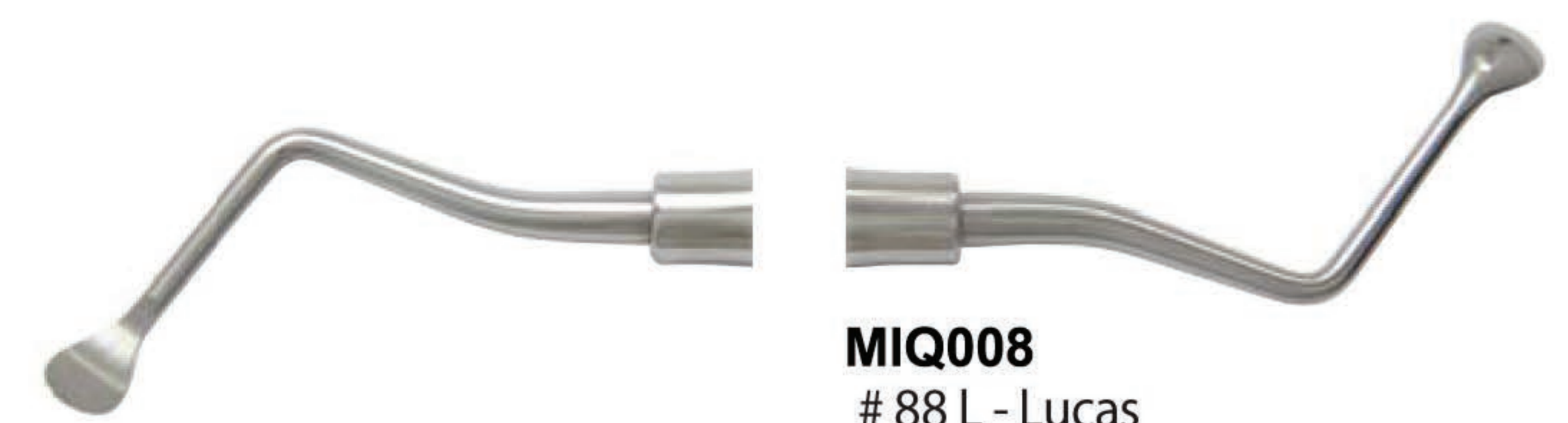

**MIQ008**  
# 88 L - Lucas



**| Periosteals**



**MIO001**  
# M 9 - Molt



**MIO002**  
# PR 3 - Prichard



**MIO003**  
# F 15 - Freer  
*Curved*



**MIO004**  
# F 16 - Freer  
*Strongly curved*



**MIO005**  
# H 1 - Hopkins



**MIO006**  
# H 2 - Hopkins



**MIO007**  
# ME 3 - Mead



**MIO008**  
# M 8 - Molt



**MIO009**  
# GF 14 - Goldman-Fox

| Periosteals



**MIO017**  
# 24 G



**MIO020**  
# SCS 02  
*Curved discoid*

| sinus-lift instruments



**MIO100**  
# 1



**MIO101**  
# 2



**MIO102**  
# 3



**MIO103**  
# 4



**MIO104**  
# 5



**MIO105**  
# 6

**| Currettes for sinus-left**



**MIO050**  
# 1

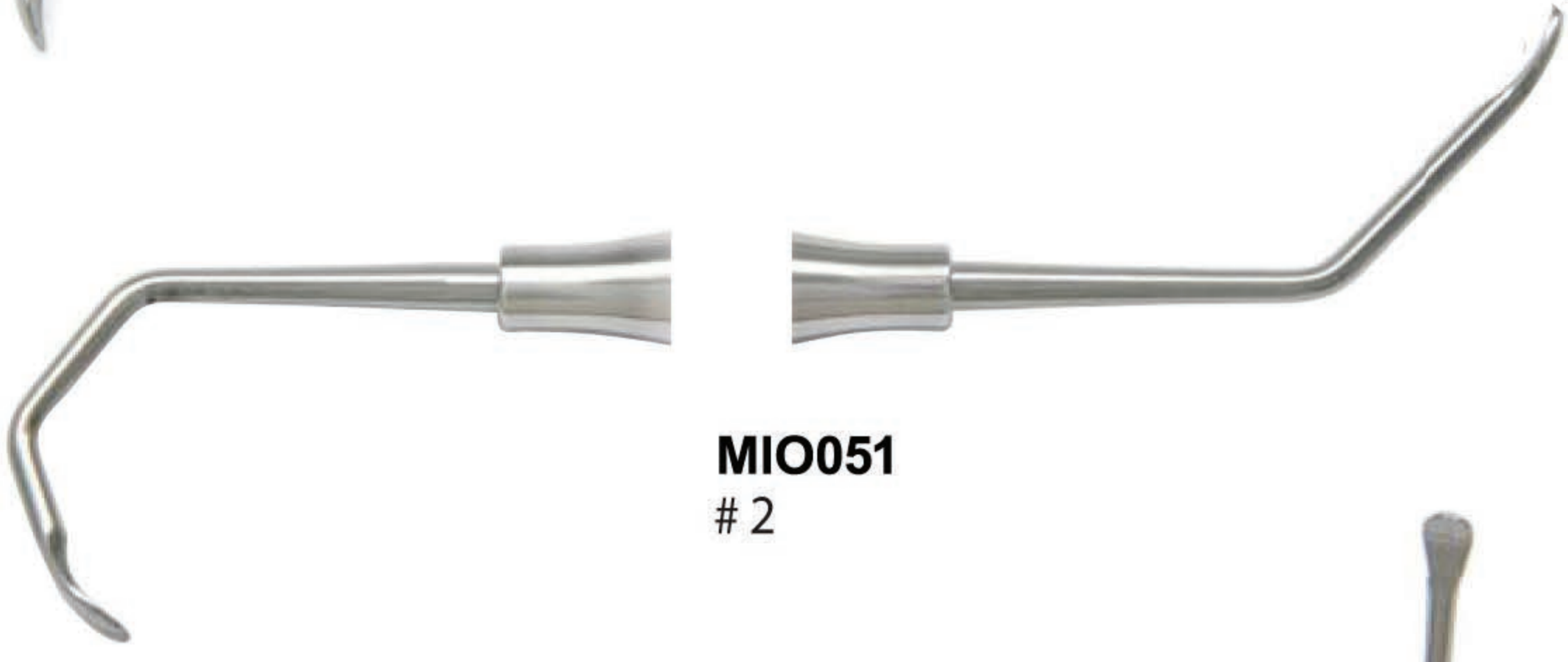

**MIO051**  
# 2

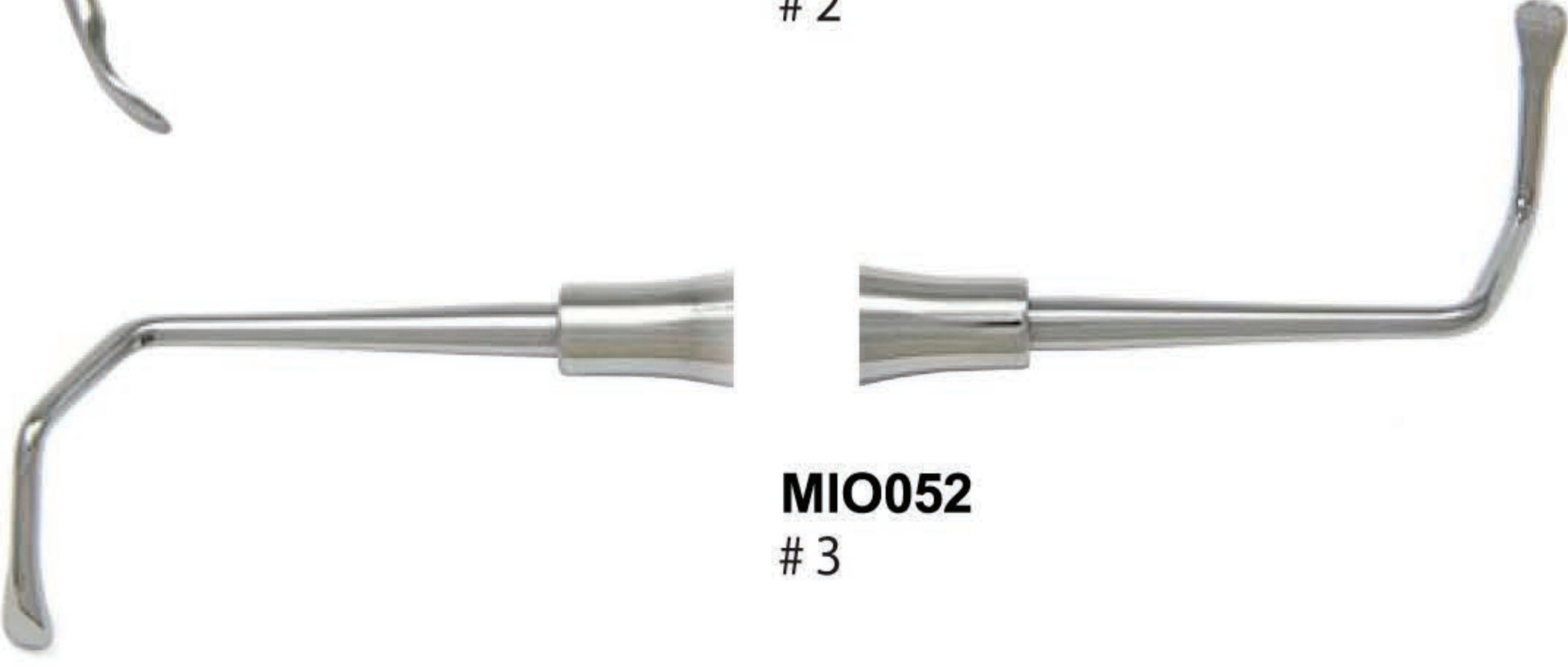

**MIO052**  
# 3

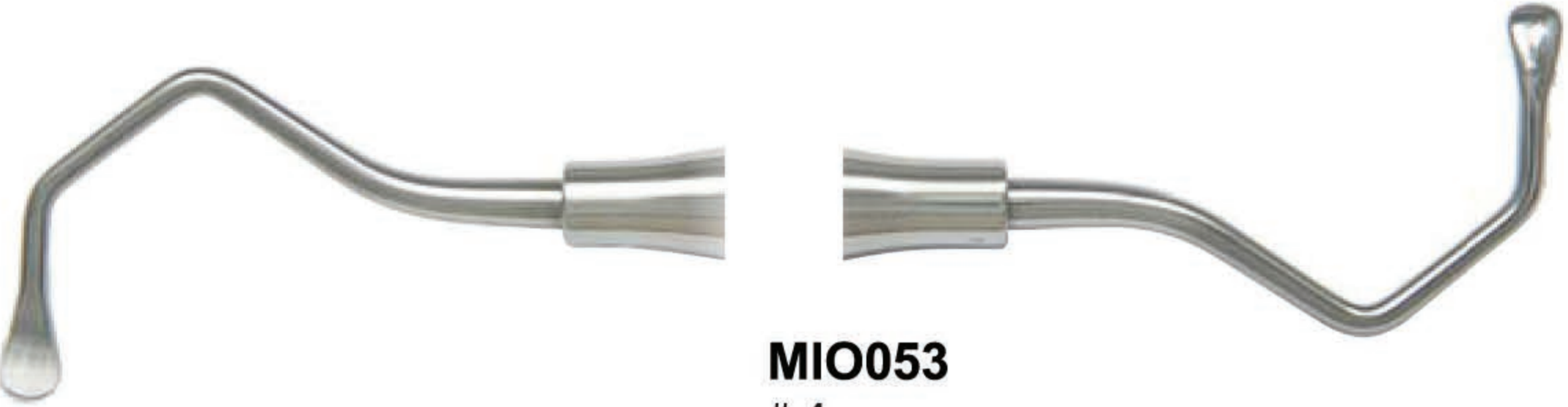

**MIO053**  
# 4

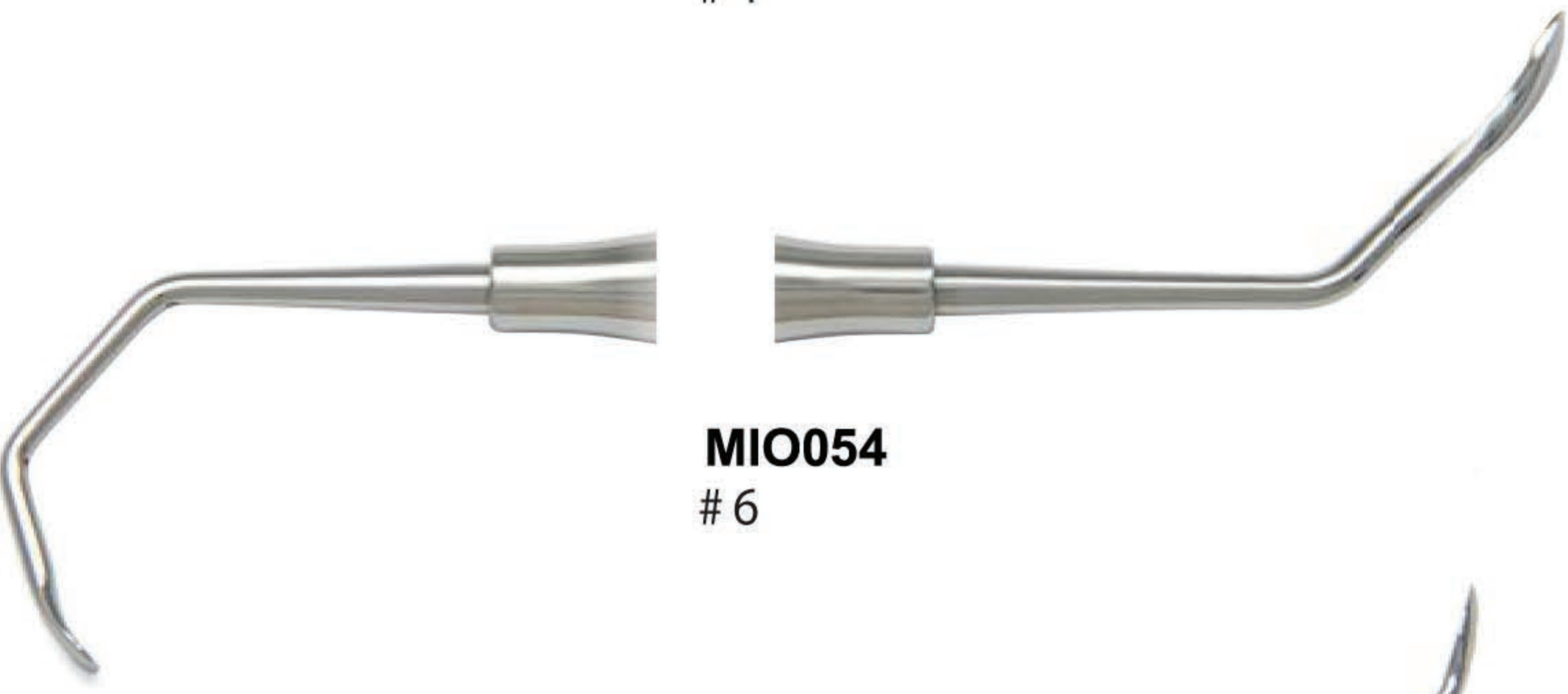

**MIO054**  
# 6



**MIO055**  
# 13





**| Tongue Depressors and malleable spatula / retractor**



**MIY001**  
# A145  
cm. 14,5



**MIY002**  
# A17  
cm. 17

**MIY016**  
# SM 16  
cm. 20



**MIY015**  
# SM 18  
cm. 20

**MIY017**  
# SM 8  
cm. 24



| **Retractors**



**MIY010**  
# S16 - Stenberg  
cm. 16

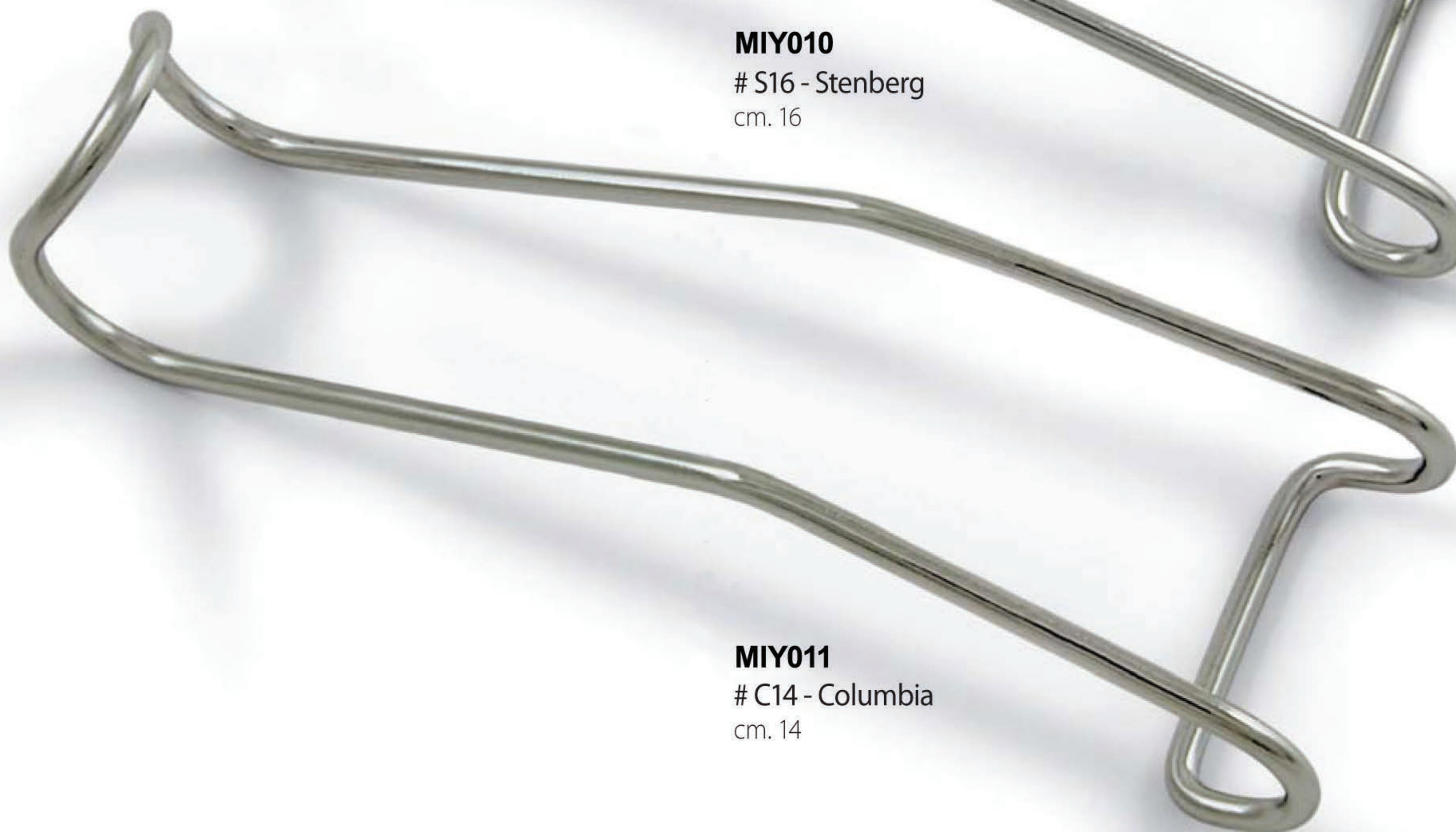

**MIY011**  
# C14 - Columbia  
cm. 14



**MIY020**  
# F 13 - Farabeuf  
cm. 13



**MIY021**  
# F 15 - Farabeuf  
cm. 15

| Retractors



**MIY024**  
# K1 - Kocher  
cm. 21 (mm. 35x11)



**MIY025**  
# K2 - Kocher  
cm. 21 (mm. 40x11)



**MIY026**  
# A1  
*Atraumatic*  
cm. 21 (mm. 42x11)

**MIY030**  
cm. 21 (mm. 35 x 19)

**MIY031**  
cm. 21 (mm. 40 x 19)

**MIY032**  
cm. 21 (mm. 55 x 19)



**| Compactors**



**MIZ210**  
# 1



**MIZ211**  
# 2



**MIZ200**  
# BB

**| bone well**



**MIZ201**  
Bone Crusher

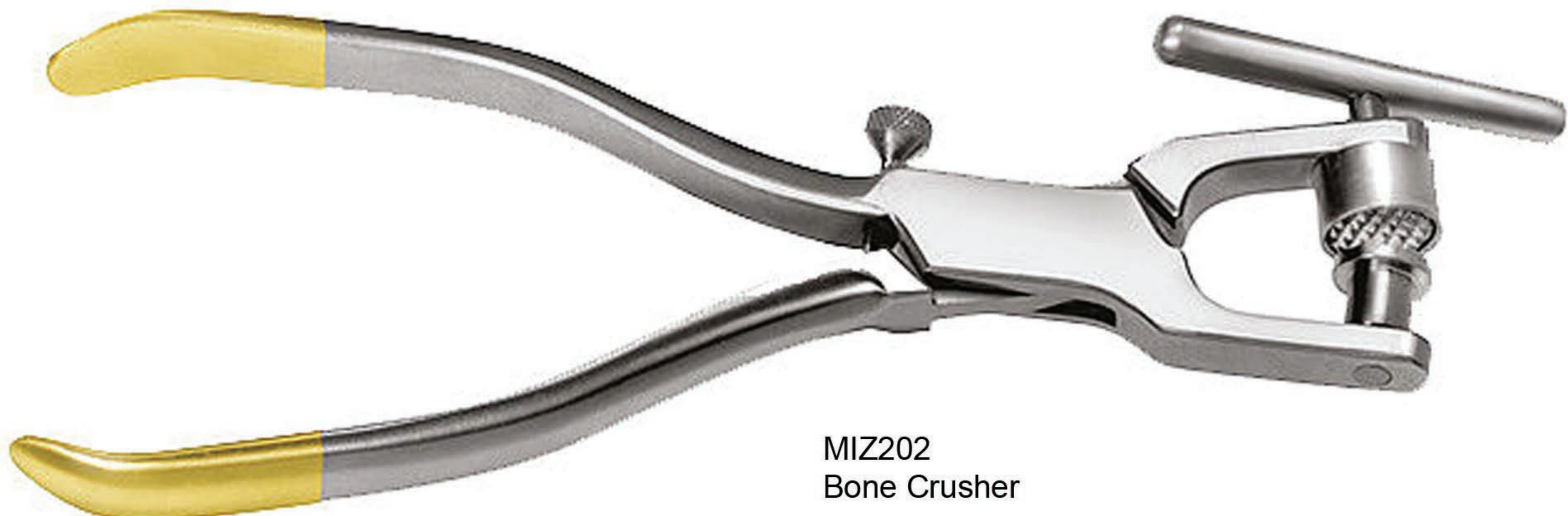

**MIZ202**  
Bone Crusher

**| Aspirators**



**MIZ001**  
# F30 - Frazier  
cm. 18

*With removable wire stylet for cleaning of the tip.*



**MIZ004**  
# C - Coupland  
Handle  
cm. 17



**MIZ006**  
# C 20  
Suction tip for ZFZ004



**MIZ007**  
# C 25  
Suction tip for ZFZ004



**MIZ008**  
# C 35  
Suction tip for ZFZ004



**MIZ009**  
# AS 30  
cm. 17



**MIZ010**  
# AS 40  
cm. 17



**MIZ011**  
# AS 50  
cm. 17

**| Gum Scissors**



**MIV001**  
# 17 - Iris Delicate  
*Straight*  
cm. 11,5

**MIV020**  
# 17 TC - Iris  
*Straight*  
cm. 11,5

**MIV050**  
# 17 SC - Iris  
*Straight*  
cm. 11,5

**MIV890**  
# 17 - Iris  
*Straight*  
cm. 11,5



**MIV002**  
# 18 - Iris Delicate  
*Curved*  
cm. 11,5

**MIV021**  
# 18 TC - Iris  
*Curved*  
cm. 11,5

**MIV051**  
# 18 SC - Iris  
*Curved*  
cm. 11,5

**MIV891**  
# 18 - Iris  
*Curved*  
cm. 11,5



*1 blade serrated, double curved.*



**MIV005**  
# 14 - La Grange  
cm. 11,5

**MIV052**  
# 14 SC - La Grange  
*1 blade serrated*  
cm. 11,5

**MIV892**  
# 14 - La Grange  
*1 blade serrated*  
cm. 11,5



*see pages 10-13*

**| Gum Scissors**



**MIV003**  
# 1 SF - Super Fine  
*Straight*  
cm. 11,5

**MIV004**  
# 2 SF - Super Fine  
*Curved*  
cm. 11,5



**MIV008**  
# 1 - Kelly  
*Straight*  
cm. 16

**MIV009**  
# 2 - Kelly  
*Curved*  
cm. 16



**MIV009**  
# 31 - Noyes  
cm. 11



**MIV013**  
# 16 RL - Goldman-Fox  
*Straight*  
cm. 13

**MIV022**  
# 16 RTC - Goldman-Fox  
*Straight*  
cm. 13



**MIV014**  
# 16 L - Goldman-Fox  
*Curved*  
cm. 13

**MIV023**  
# 16 TC - Goldman-Fox  
*Curved*  
cm. 13



| **Surgical Scissors**



**MIV030**  
# 1MD - Metzenbaum  
Delicate  
Retta - Straight  
cm. 14,5



**MIV031**  
# 2MD - Metzenbaum  
Delicate  
Curva - Curved  
cm. 14,5



**MIV040**  
# 1MFTC  
Metzenbaum Fino  
cm. 14,5



**MIV028**  
# 1JTC - Joseph  
Curved sharp  
cm. 14



**MIV029**  
# 2JTC - Joseph  
Curved blunt  
cm. 14

| **suture scissors**



**MIV035**  
# S 11 - Spencer  
For sutures  
cm. 11



**| Needle Holders**



**MIW001**  
# MH16 - Mayo-Hegar  
cm. 16



**MIW002**  
# CW15 - Crile-Wood  
cm. 15



**MIW003**  
# M14 - Mathieu  
cm. 14



**MIW004**  
# CV14R - Castroviejo  
*Straight*  
cm. 14



**MIW005**  
# CV14C - Castroviejo  
*Curved*  
cm. 14

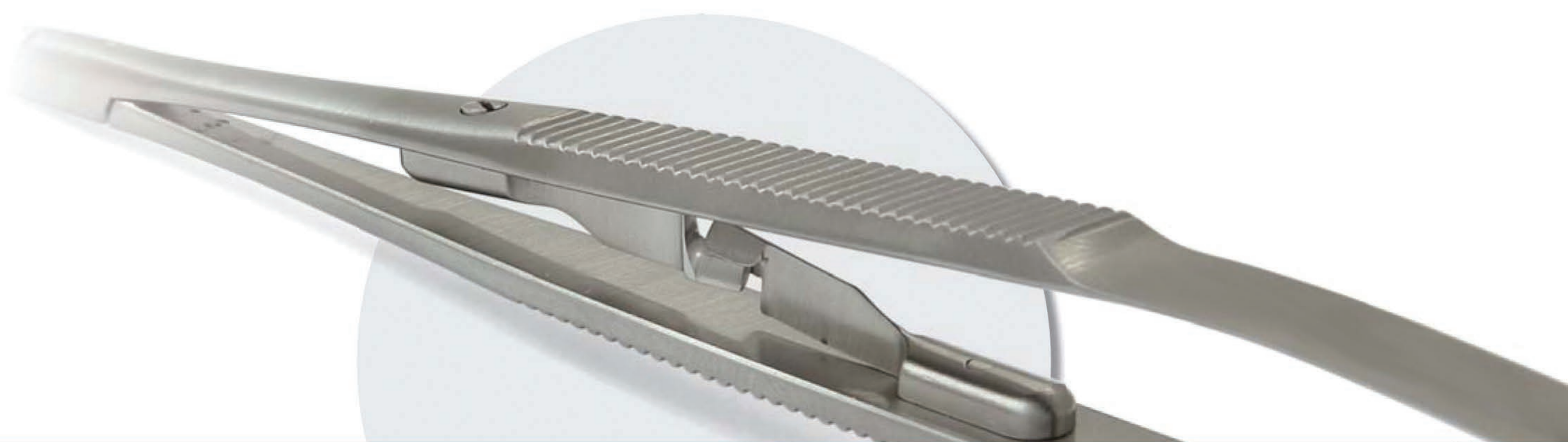

| Needle Holders with tungsten carbide inserts



**MIW010**  
# MH16T - Mayo-Hegar  
cm. 16



**MIW011**  
# CW15T - Crile-Wood  
cm. 15



**MIW013**  
# MR15T - Mini Ryder  
cm. 15



**MIW014**  
# OH14T - Olsen-Hegar  
cm. 14



**MIW014**  
# M14T - Mathieu  
cm. 14



*Tungsten carbide inserts with  
ground pyramidal profile:  
firm and positive grip of needle.*

**| Needle holders with tungsten carbide inserts**



**MIW021**  
# J18RT - Jacobson  
*Straight*  
cm. 18



**MIW022**  
# J18CT - Jacobson  
*Curved*  
cm. 18



**MIW042**  
# MC15TC - Micro-Vascular  
cm. 15

**MIW043**  
# MC18TC - Micro-Vascular  
cm. 18



**MIW019**  
# CV14RT - Castroviejo  
*Straight*  
cm. 14



**MIW020**  
# CV14CT - Castroviejo  
*Curved*  
cm. 14



**MIW025**  
# CR14RT - Castroviejo  
*Straight*  
cm. 14



**MIW026**  
# CR14CT - Castroviejo  
*Curved*  
cm. 14

| **Hemostats**



**MIX001**  
# HMR - Mosquito  
*Straight*  
cm. 12



**MIX002**  
# HMC - Mosquito  
*Curved*  
cm. 12



**MIX005**  
# KR - Kocher  
*Straight*  
cm. 14



**MIX006**  
# KC - Kocher  
*Curved*  
cm. 14

| **sterilizing forceps**



**MIX020**  
# PS 20  
cm. 20

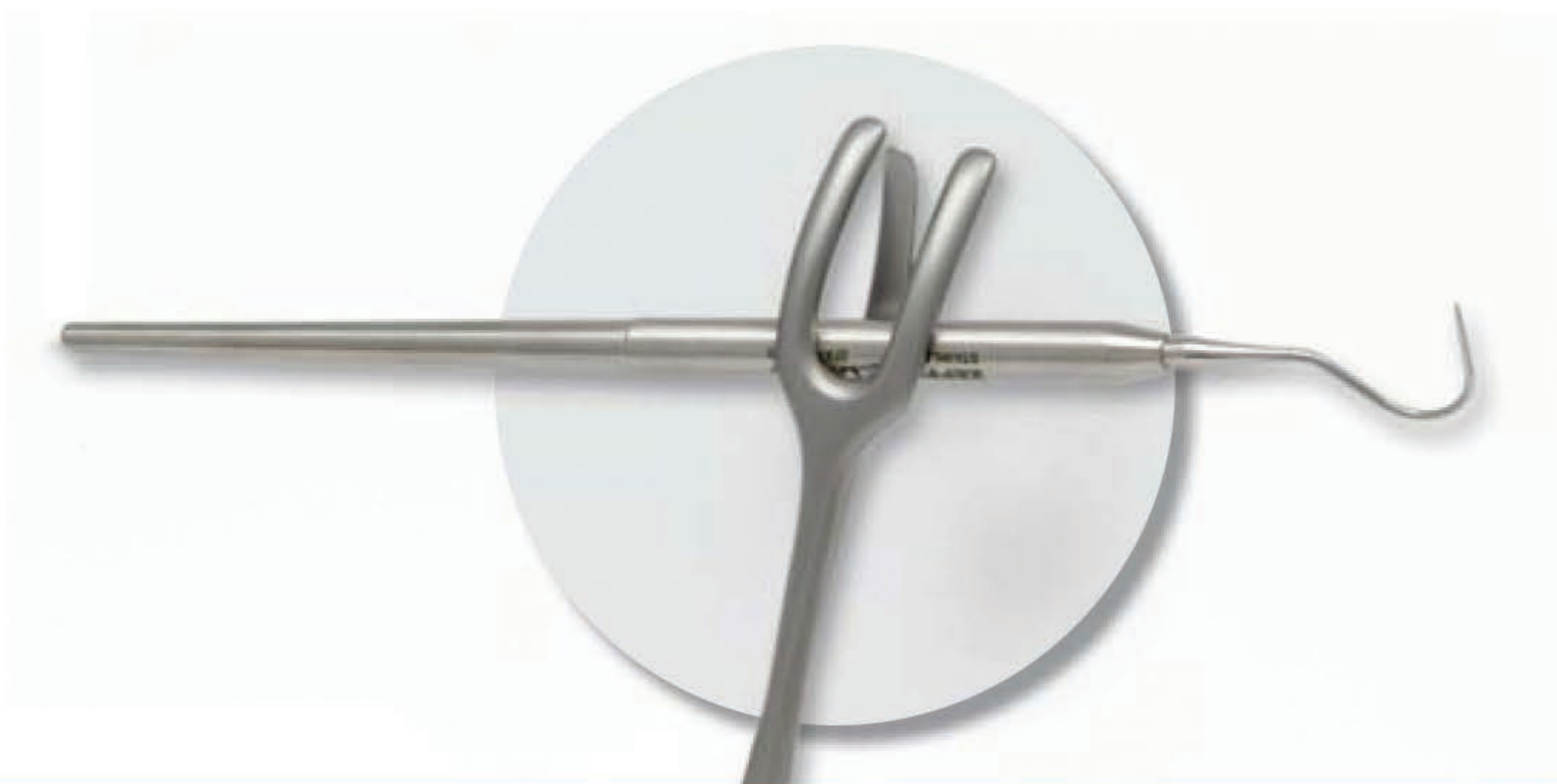

**| Tissue Pliers**



**MIR030**  
# 41 - Adson  
cm. 12 - mm.1,5



**MIR031**  
# 41D - Adson Delicate  
cm. 12 - mm.1,2



**MIR032**  
# 42 - Adson 1x2  
cm. 12 - mm.1,5



**MIR033**  
# 42D - Adson Delicate 1x2  
cm. 12 - mm.1,2

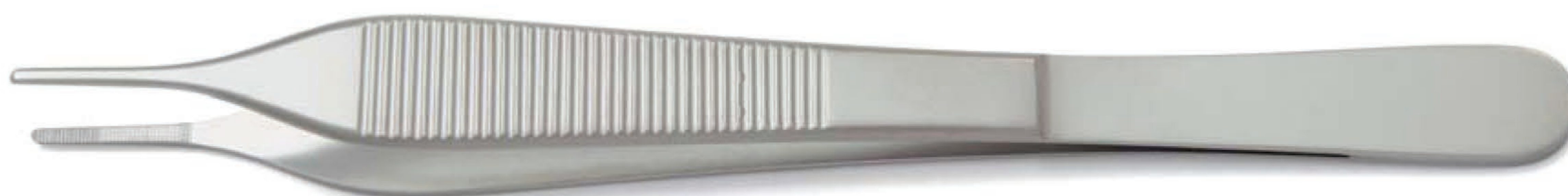

**MIR040**  
# 41L - Adson  
cm. 15 - mm.1,5



**MIR042**  
# 42L - Adson 1x2  
cm. 15 - mm.1,5



*Detail of the retentive profile of tweezers 1x2.*

**Surgical tweezers**

*The wide range of tweezers, made of a special steel alloy that gives them a proper elasticity, sensitivity and optimal grip, minimizes the risk of excessive trauma in periodontal tissues.*

**| Tissue Pliers**



**MIR035**  
# 31 - Semken-Taylor  
Straight  
cm. 12,5



**MIR036**  
# 32 - Semken-Taylor  
Curved  
cm. 12,5



**MIR037**  
# 33 - Semken-Taylor 1x2  
Straight  
cm. 12,5



**MIR045**  
# 31L - Semken-Taylor  
Straight  
cm. 15



**MIR046**  
# 32L - Semken-Taylor  
Curved  
cm. 15



**MIR038**  
# 34 - Semken-Taylor 1x2  
Curved  
cm. 12,5



**MIR054**  
# 90 - De Bakey-Vascular  
Straight  
cm. 16



**MIR055**  
# 90C - De Bakey-Vascular  
Angulated  
cm. 16



**MIR056**  
# 62 - Taylor  
Bayonet -

**| Periostomes**



**MIT200**  
# PM  
Handle



**MIT201**  
# PD1  
Straight  
1,6 mm.



**MIT203**  
# PC1  
Curved  
1,6 mm.



**MIT205**  
# PA1  
Angulated  
1,6 mm.



**MIT202**  
# PD2  
Straight  
2,5 mm.



**MIT204**  
# PC2  
Curved  
2,5 mm.



**MIT206**  
# PA2  
Angulated  
2,6 mm.

**| syndesmotomes**



**MIT100**  
Handle



**MIT101**  
# SYB 0



**MIT102**  
# SYB 2



**MIT103**  
# SYB 3



**MIT104**  
# SYB 4



**MIT105**  
# SYB 5



**MIT071**  
# 2 - Chompres  
cm. 16

**Extracting Forceps, Meissner**

*With only three pliers you can extract any tooth in the upper or lower arch, on the left or right side.*

*A new frontier has been achieved. Lascod has created the series of Meissner pliers, keeping in mind the importance of easy cleaning and sanitation. The smooth handle and, above all, the fact that they can be totally and easily dismantled ensures maximum hygiene even in those parts that are usually inaccessible.*





**Extracting Forceps, Meissner**



**MIS300**  
Meissner

*For root fragment*

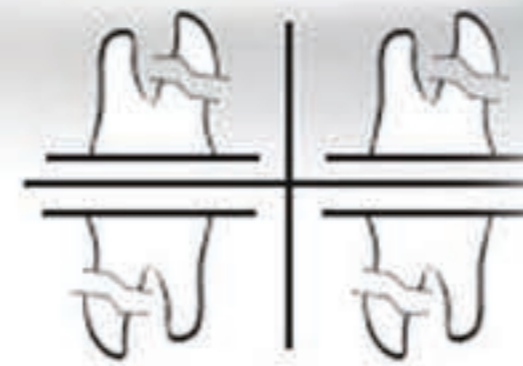

**MIS301**  
Meissner

*Universal, medium*

5...1	1...5
5...1	1...5

*The special ergonomic design makes these pliers extremely handy. The inclination and the tips are designed to maximize the grip of any tooth in the two dental arches.*



**MIS302**  
Meissner

*Universal, large*

8...6	6...8
8...6	6...8

**Meissner pliers. Smooth handle. May be dismantled. Three models to meet all requirements of extraction. Exclusive design.**



*Dimensions 1:1*

**Extracting Forceps**

Upper incisors  
and canines.



Lower incisors  
and canines.

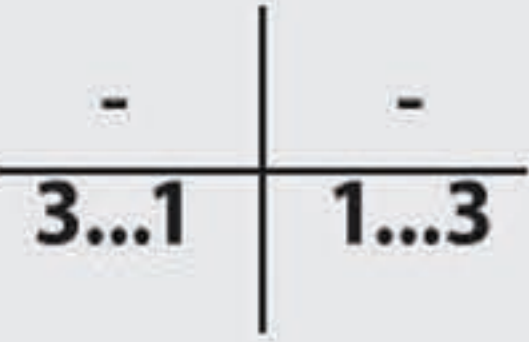

Upper  
premolars.



Dimensions 1:1

**Extracting Forceps**



**MIS130**  
# 13

*Lower premolars.*



**MIS140**  
# 17

*Upper molars, right.*



**MIS141**  
# 89

*Upper molars, left.*



**MIS145**  
# 18



**MIS146**  
# 90

Dimensions 1:1

**Extracting Forceps**



**ZFS130**  
# 13

*Lower premolars.*



**ZFS140**  
# 17

*Upper molars, right.*



**ZFS141**  
# 89



**ZFS145**  
# 18

*Upper molars, left.*



**ZFS146**  
# 90

Dimensions 1:1

Extracting Forceps

Lower  
molars.



MIS150  
# 73



MIS151  
# 22



MIS152  
# 321

Upper third  
molars.



MIS170  
# 67A

Lower third  
molars.



MIS175  
# 79A

Dimensions 1:1

Extracting Forceps



**MIS160**  
# 51ZS

Upper roots.

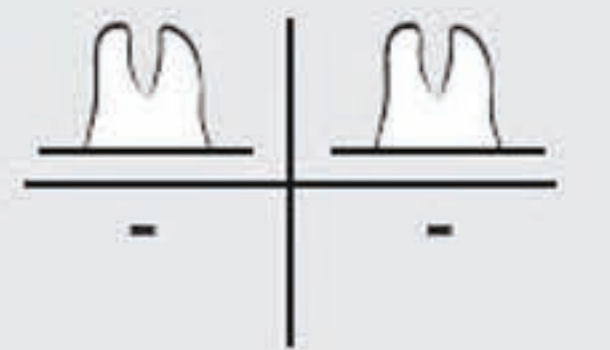

**MIS161**  
# 44Z



**MIS160-1**  
# 51



**MIS165**  
# 45ZS

Lower roots.

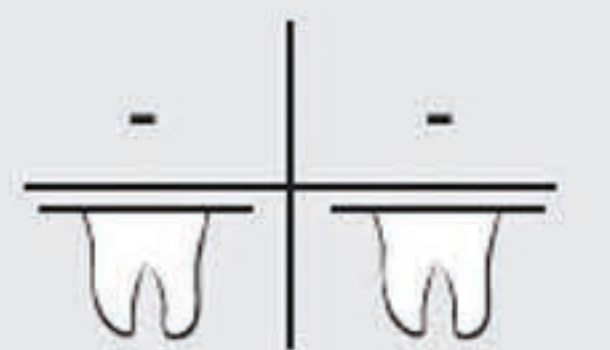

**MIS166**  
# 59



**MIS180**  
# W

Roots and root fragments

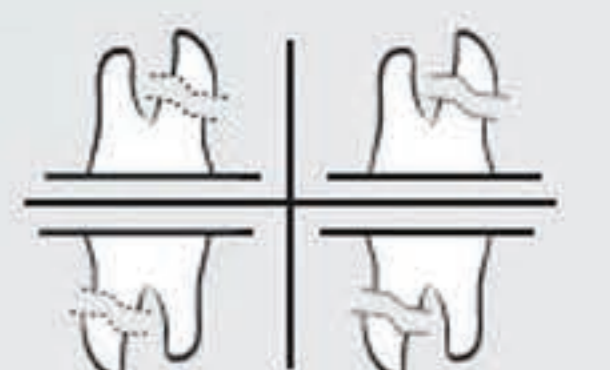

**MIS181**  
# W1



**MIS182**  
# W2

Dimensions 1:1

**| Bone Rongeurs**



**MIS052**  
# B45 - Blumenthal 45°  
cm. 14,5



**MIS053**  
# B90 - Blumenthal 90°  
cm. 14,5



**MIS054**  
# MF - Mini Friedman  
cm. 15



**MIS055**  
# FL - Friedman  
cm. 16,5



**MIS055-1**  
# MF90 - Mini Friedman 90°  
cm. 14



**MIS056**  
# FS - Friedman  
cm. 14



**MIS061**  
BONE RONGEURS BEYER  
DOUBEL ACTION 18CM



**MIS061-1**  
BONE RONGEURS BEYER  
DOUBEL ACTION  
RUSKIN-MINI 15.5CM



**MIS057**  
# CH - Cohen  
- Tissue nipper  
cm. 10

**| Root Elevators**



**MIT001**  
# 2B - Bein  
mm. 2



**MIT002**  
# 3B - Bein  
mm. 3



**MIT003**  
# 4B - Bein  
mm. 4



**MIT081**  
# 2BFT - Bein  
*Flat tip*  
mm. 2



**MIT082**  
# 3BFT - Bein  
*Flat tip*  
mm. 3



**MIT083**  
# 4BFT - Bein  
*Flat tip*  
mm. 4



**MIT004**  
# F1 - Flohr



**MIT005**  
# F2 - Flohr



**MIT006**  
# F3 - Flohr



**MIF008**  
# 12A - Apical



**MIF009**  
# 13A - Apical



**MIT011**  
# 1C - Coupland  
mm. 2



**MIT012**  
# 2C - Coupland  
mm. 3



**MIT013**  
# 3C - Coupland  
mm. 4



**| Root Elevators**



**MIT049**  
# 20  
Curved tip  
mm. 2



**MIT051**  
# 30  
Curved tip  
mm. 3



**MIT053**  
# 40  
Curved tip  
mm. 4



**MIT038**  
# LL - Lindo Levien  
mm. 3



**MIT014**  
# 27CR - Cryer



**MIT015**  
# 28CR - Cryer



**MIT040**  
# 71MA - Miller-Apexo



**MIT041**  
# 72MA - Miller-Apexo



**MIT057**  
# 11B - Bernard



**MIT058**  
# 6B - Bernard



**MIT059**  
# 7B - Bernard

**| Extracting Forceps of Children - Klein Style**



III...I	I...III
-	-

**MIS091**  
# 2

Upper Incisors and Canines



**MIS092**  
# 7

V...IV	IV...V
-	-

Upper Premolars



**MIS093**  
# 33

-	-
III...I	I...III

Lower Incisors, Canines and Roots



**MIS094**  
# 13

-	-
V...IV	IV...V

Lower Premolars



**MIS095**  
# 22

-	-
V...IV	IV...V

Lower Molars



**MIS096**  
# 51

V...IV	IV...V
-	-

Upper Roots

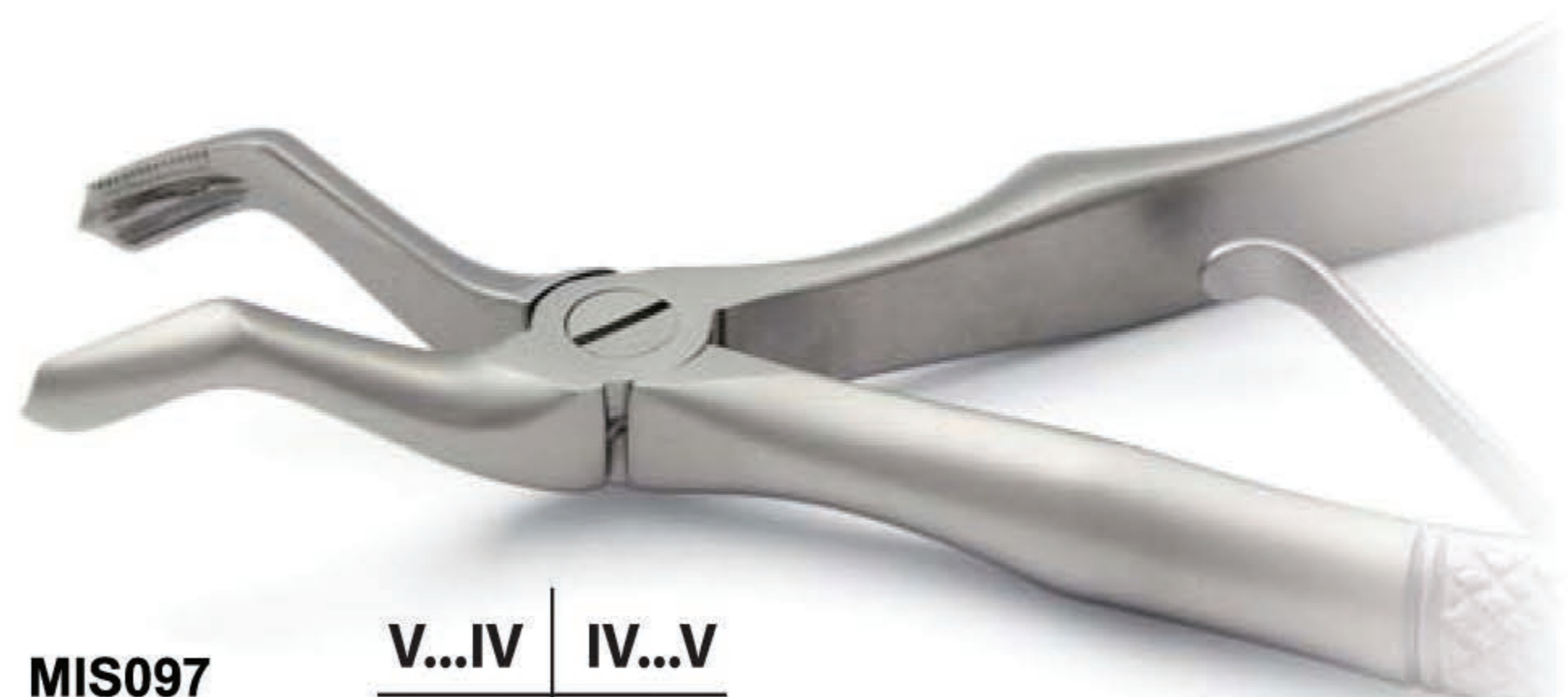

**MIS097**  
# 52

V...IV	IV...V
-	-

Upper Molars

**| Root Tip Pick/Teaser**



**MIT021**  
# 1HD - Heidbrink



**MIT022**  
# 2HD - Heidbrink



**MIT023**  
# 3HD - Heidbrink

**root fragments removing pliers**



**MIC070**  
# 1 - Stieglitz



**MIC071**  
# 2 - Stieglitz

**| luxators**



**MIT301**  
# L2ST  
Straight  
mm. 2



**MIT302**  
# L3ST  
Straight  
mm. 3



**MIT303**  
# L4ST  
Straight  
mm. 4



**MIT311**  
# L2C  
Curved  
mm. 2



**MIT312**  
# L3C  
Curved  
mm. 3



**MIT313**  
# L4C  
Curved  
mm. 4

# Orthodontics



**| Pliers**



**MIH519**  
Round/concave plier  
For wires up to 0.028"  
(0.71 mm)



**MIH503**  
Tweed loop  
forming plier  
For wires up to 0.060" (1.52 mm);  
0.090" (2.28 mm); 0.120" (3.04 mm)



**MIH504**  
Loop  
forming plier Tweed style  
For round and rectangular wires.  
Replaceable cylindrical beak with three sizes: 0.045"  
(1.14 mm); 0.060" (1.52 mm); 0.075" (1.90mm)



**MIH5506**  
Loop closing plier Nance style  
For round and rectangular wires. Wire max 0.028"  
(0.71mm)



**MIH507**  
Rectangular arch/ ribbon arch plier  
For square/rectangu-  
lar section wire of 0.022"(0.56mm); 0.028"(0.71mm)



**MIH507**  
Lingual arch plier  
To form double or triple back bends in  
wires of 0.030" (0.76 mm); 0.036" (0.91mm)



**MIH509**  
Arch forming and contouring plier  
For wires of 0.016" (0.41mm);  
0.018"(0.46mm); 0.022" (0.56mm)



**MIH510**  
- Arch forming plier, without  
groves,



**MIH702**  
Accessories for MIH504



**MIH704**  
Accessories MIH504 - Accessories for MIH504

**| Pliers**



**MIH511**  
Three  
medium jaw plier Aderer bending  
For wires up to 0.036"  
(0.91 mm)



**MIH512**  
Hollow-Chop plier  
To form and contour arches, designed for  
NICKEL TITANIUM



**MIH512**  
Rounded jaw wire bending pliers, short beak  
To bend wires up to 0.029" (0.74 mm)



**MIH516**  
Rounded jaw wire bending pliers, long beak  
To bend wires up to 0.020" (0.51 mm)



**MIH512**  
Bird beak  
Angle plier  
To bend round wires up to 0.045" (1.14 mm)



**MIH505**  
Bird beak long plier  
For small  
loop forming. For light wires of 0.016" (0.41mm); 0.018"  
(0.46 mm)



**MIH518**  
Jarabak plier  
To curve thin wires and loop form-  
ing; 3 flute up to 0.020" (0.51 mm)



**MIH513**  
Adams plier  
Designed for bending wires up to 0.036" (0.91 mm)



**MIH514**  
Laboratory bird beak long plier  
Designed for loop forming and  
bending wires up to 0.018" (0.46 mm)

**| Pliers**



**MIH530**  
Steel and ceramic D.B. bracket  
removing plier  
Replaceable ends



**MIH535**  
Direct bond bracket removing angled plier.



**MIH532**  
Posterior band removing long plier  
Plastic pad



**MIH533**  
Posterior band removing short plier  
Plastic pad



**MIH534**  
Band seating plier  
For positioning of  
D.B brackets



**MIH520**  
How plier-straight  
For modeling and positioning of wires and  
bands, with serrated tips.



**MIH521**  
How plier-curved  
For modeling and positioning of wires and  
bands, with serrated tips.



**MIH701**  
Accessories for MIH530



**MIH524**  
Utility plier  
Weingart TC  
Tungsten  
carbide insert.



**MIH731**  
Accessories for ZLH530



**MIH730**  
Accessory for MIH532 and MIH533

**| Cutters/distal and Cutters With Tungsten Carbide Inserts**



**MIH545**  
Hard wire  
cutter TC, straight.  
Hard wire, max 0.022" x 0.028" (0.56mm x 0.71mm)



**MIH544**  
Mini  
pin and ligature cutter TC, straight.  
Max 0,015" (0,38 mm).



**MIH547**  
- Mini pin and ligature cutter TC, angled 15°. Max 0,015" (0,38 mm).



**MIH541**  
filo - Mini distal and cutter TC with safety hold.  
Max 0,022" x 0,028" (0,56 mm x 0,71 mm).



**MIH540**  
- Distal and cutter TC with safety hold.  
Max 0,022" x 0,028" (0,56 mm x 0,71 mm).



**MIH542**  
Flush cut distal and  
cutter TC.  
Max 0,022" x 0,028" (0,56 mm x 0,71 mm).



**MIH549**  
Mini distal and cutter TC  
with safety hold, long handle.  
Max 0,022" x 0,028" (0,56 mm x 0,71 mm).



| **D.B. Brackets Holder**



**MIH560**  
*Straight*



**MIH561**  
*Angulated*

| **orthodontic ligature pliers**



**MIH561**  
# MD14  
*Mathieu style*  
cm. 14



**MIW007**  
# OLP  
*Smaha style*  
cm. 14



**| Utility Instruments**



**MIH550**  
Ligature  
tying plier  
Flared-tip metal plier for tying ligatures



**MIH551**  
Force  
modular separator  
For positioning separating elastics



**MIH120**  
# AS  
Band setting and  
removing instrument



**MIH121**  
# DC  
Ligature instrument, curved.



**MIH122**  
# DR  
Ligature instrument, straight.



**MIH123**  
# AL  
Elastic setting instrument

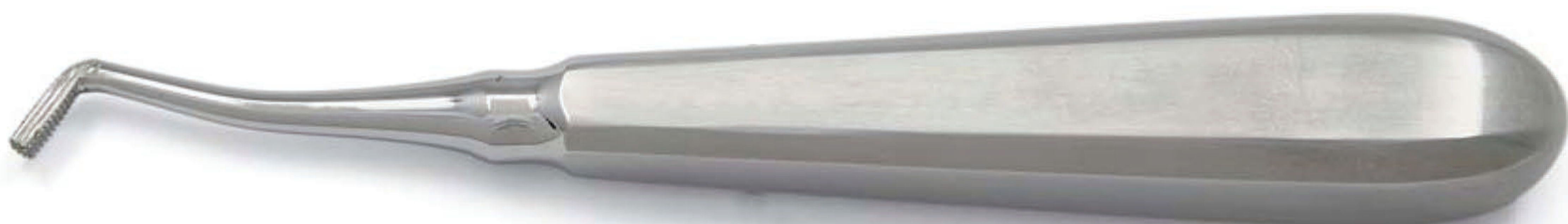

**MIH124**  
Band pusher-Mershon  
cm. 14

# Laboratory



| Wax Carvers



**MIL001**  
# HL - Hylin



**MIL002**  
# HL-LC - Hylin-Lecron



**MIL003**  
# HL-C - Hylin-Ceramic



**MIL004**  
# HL-SP - Hylin-Spoon



**MIF004**  
# LC 1 - Lecron



**MIL008**  
# ZH 1 - Zahle



**MIL009**  
# ZH 2 - Zahle



**MIL010**  
# ZH 3 - Zahle



**MIL011**  
# GR - Gritman



**MIL012**  
# BA - Beale

| P.K. Thomas Waxing Instruments

- Aluminium handle Ø 8 mm.



**MIL040**  
# PKT 1V



**MIL041**  
# PKT 2G



**MIL042**  
# PKT 3V



**MIL043**  
# PKT 4R



**MIL044**  
# PKT 5A

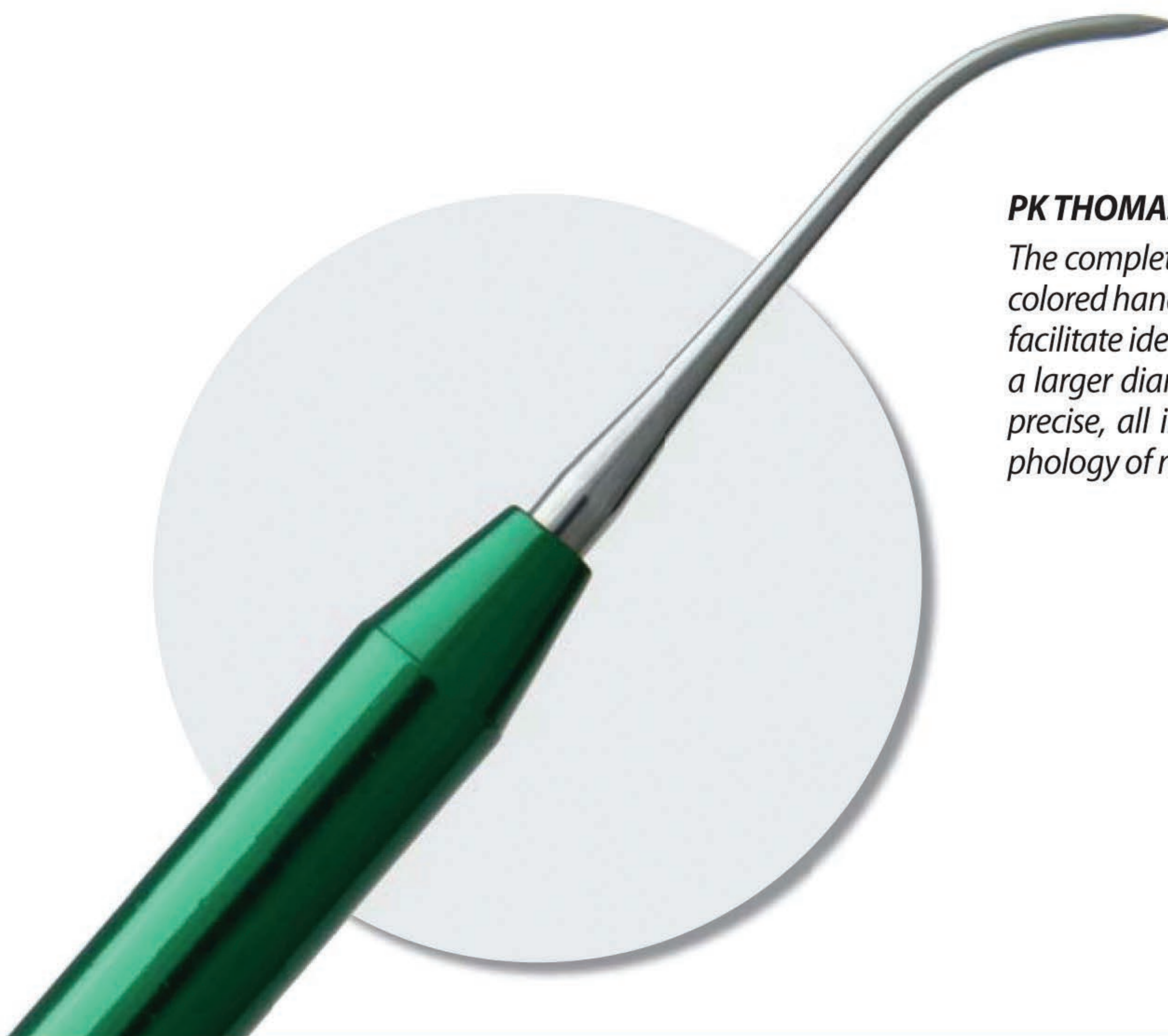

**PK THOMAS spatulas:**

The complete set of PK THOMAS spatulas used for waxing is offered with a colored handle (green, gold, blue, red, steel) made of anodized aluminum to facilitate identification in the dental laboratory. The aluminum handle with a larger diameter (8 mm) makes the instrument lightweight, sensitive and precise, all important features to reproduce the correct anatomical morphology of natural teeth.

**| Ceramic Sculpturing Instruments**

- Aluminium handle  
- 2 tips included



**MIL050**  
# 1 G



**MIL051**  
# 2 R



**MIL052**  
# 3 B



**MIL060**  
# GR 1G - Greenstein



**MIL061**  
# GR 2R - Greenstein



**MIL062**  
# GR 3B - Greenstein



**MIL071**  
# 1 A SF



**MIL072**  
# 2 A SF



**MIL073**  
# 3 A SF

Superflexible tips, thickness 1/10



**MIL081**  
# 1 BF



**MIL082**  
# 2 BF



**MIL083**  
# 3 BF

Flexible tips, thickness 2/10

| Wax Knives



**MIA001**  
# 1 F - Fahnenstock  
cm. 12,5



**MIA002**  
# 2 F - Fahnenstock  
cm. 17



**MIA003**  
# 1 L - Lessman  
cm. 12,5



**MIA004**  
# 2 L - Lessman  
cm. 17

| plaster knives



**MIB001**  
# PK 1  
cm. 17



**MIB002**  
# GR - Grittman  
cm. 17



**MIB005**  
# 3

| **Mixing Spatulas**



**MIC001**  
# 1 SA  
*Rigid*  
cm. 18,5



**MIC003**  
# 3 SA  
*Flexible*  
cm. 21,5



**MIC010**  
# 1 SS  
*Flexible*  
cm. 18,5



**MIC011**  
# 2 SS  
*Flexible*  
cm. 20,5



**| Crown Scissors**



**MID001**  
# 1 L 100  
Retta - Straight  
cm. 10



**MID002**  
# 2 L 100  
Curva - Curved  
cm. 10

**| gold foil scissors**



**MID010**  
# 1 G  
Straight  
cm. 12



**MID011**  
# 2G  
Curved  
cm. 12

**| scalpel handles**



**MIU010**  
# 4



**MIU011**  
# 8

**| alcohol lamp**



**MID010**  
# LA



**MIG011**  
Spare wicks for alcohol lamp

| Laboratory Pliers



**MIE011**  
# U 18 - Universal  
cm. 18



**MIE012**  
# U25 - Universal  
cm. 25



**MIG005**  
# U - Universal  
cm. 15  
For wires up to 0.036" (0.91 mm)



**MIH201**  
# U3 - Universal  
cm. 16  
For wires up to 0.036" (0.91 mm)



**MIG020**  
# PCP  
Plaster cutting plier  
cm. 19

**| Mallets - Calipers**



**MIG002**  
# MP  
Plate tip  
cm. 22



**MIL010**  
# BO - Boley  
0 - 100 mm.



**MIL001**  
# IWW - Iwanson  
For wax



**MIL002**  
# IWM - Iwanson  
For metal

**| Insulated Soldering Tweezers**



**MIE001**  
# 1  
*Straight*  
cm. 16,5



**MIE002**  
# 2  
*Curved*  
cm. 16,5

**| crucible tongs**



**MII001**  
# P 51  
cm. 51



**MII002**  
# P 43  
cm. 43

**Impression Trays**

*The absence of solder and retention edges facilitate the removal of residual material which is a breeding ground for blood, spores and bacteria in the mouth.*



*EXPLOIT has been designed bearing in mind the oral anatomy and an optimal distribution of the impression material, thus offering greater comfort to the patient.*



*Perforated and non-perforated EXPLOIT trays are compatible with all impression materials and are available with a micro-sand blasted satin finish for even more retention.*



## Impression Trays



XS



S



M



L



XL

SHAPES	Width mm.	Length mm.	Perforated	Non-perforated
<b>UPPER</b>				
XS	62	50	EXF112	EXL312
S	66	53	EXF113	EXL313
M	69	57	EXF114	EXL314
L	72	60	EXF115	EXL315
XL	80	63	EXF115	EXL316

	mm.	mm.		
<b>LOWER</b>				
XS	60	49	EXF212	EXL412
S	72	53	EXF213	EXL413
M	75	57	EXF214	EXL414
L	78	60	EXF215	EXL415
XL	80	63	EXF216	EXL416

“We manufacture custom design impression trays, if you are looking the impression trays that are not listed here, you can let us know their image, reference number of any catalog, or drawing, We will manufacture for you cost-effectively with top quality standard .”



## Maling Address

### **Medicure Instruments**

Defance Road, Sardar  
Pura, Muzaffar Pur  
51310 Sialkot  
Pakistan.

### **Whatsapp#**

+92 306 6124344

### **Telephone#**

+92 306 6124344

### **Email:**

info@medicure.pk

### **URL Website:**

www.medicure.pk

### **Facbook**

www.facebook.com/DentalinstrumentsSupplier/

### **Twitter:**

www.twitter.com/medicure\_dental

### **Instagram:**

www.instagram.com/dentalinstrumentscompany/

### **Linkedin:**

www.linkedin.com/in/  
dental-instruments-manufacturer-pakistan

### **Pinterest:**

www.pinterest.com/medicure\_instruments/